

Product range  
PVC-U

Ball valve type 375  
metric, BS, ASTM



# List of Abbreviations

---

ASTM	American Society for Testing and Materials
BS	British Standard
DIN	Deutsches Institut für Normung e.V.
EN	Europäische Norm
ISO	International Standardization Organization
PVC-U	Polyvinyl chloride, unplasticized
PE	Polyethylene
EPDM	Ethylene-Propylene-Rubber
FPM	Fluororubber, e.g. Viton®
PTFE	Polytetrafluoroethylene, e.g. Teflon®
d	Pipe outer diameter
DN	Nominal diameter
PN	Nominal pressure at 20 °C, water
kg	Weight in kilograms
®	Registered trademark

The technical data are not binding and not expressly warranted characteristics of the goods. They are subject to change. Our General Conditions of Sale apply.

## **Dimensions**

All dimensions are given in mm.

# Table of Contents

---

<b>The new ball valve type 375</b>	4
<hr/>	
<b>Technical features</b>	5
<hr/>	
<b>PVC-U metric</b>	
Ball valve type 375 PVC-U with solvent cement sockets metric	6
Ball valve type 375 PVC-U with threaded sockets Rp	7
Ball valve type 375 PVC-U with butt fusion spigots long	
PE100 SDR11 metric	8
Ball valve type 375 PVC-U with PVC-U fixed flanges serrated metric	9
<hr/>	
<b>PVC-U Inch BS</b>	
Ball valve type 375 PVC-U with solvent cement sockets Inch BS	10
<hr/>	
<b>PVC-U ASTM / ANSI</b>	
Ball valve type 375 PVC-U with solvent cement sockets Inch ASTM	11
<hr/>	
<b>Valve ends ball valve type 375</b>	12-14
<hr/>	
<b>Spare parts ball valve type 375</b>	15

---

# The new ball valve type 375

With the Type 375 ball valve, GF Piping Systems now have a new addition to their existing ball valve range. The ball valve 375 is ideally suited for basic applications encompassing the water processing/treatment sector, as well as other applications involving water.







## Features:

- Material PVC-U
- DN10 – DN100
- Pressure rates  
DN10 – DN50 = PN16  
DN65 – DN100 = PN10
- O-Ring Material EPDM / FPM
- Actuator unit not connectable

## The ball valve type 375 conforms to the following international standards:

EN ISO 16135	Industrial valves – Ball valves of thermoplastic materials
ISO 9393	Thermoplastic valves – pressure test methods and requirements
EN 558	Flanged valve dimensions are in accordance with EN 558

## End connectors:

<b>Solvent cement socket</b>	<b>Norm</b>
	ISO, BS, ASTM, JIS
<b>Threaded socket</b>	<b>Norm</b>
	ISO / BS (Rp), ASTM (NPT)
<b>Butt fusion spigot PE100 SDR11 long</b>	<b>Norm</b>
	ISO
<b>PVC-U Flanges</b>	<b>Norm</b>
	ISO (fixed flange), BS (fixed flange), ASTM (backing flange US modified)

# Technical features

Single parts ball valve type 375:

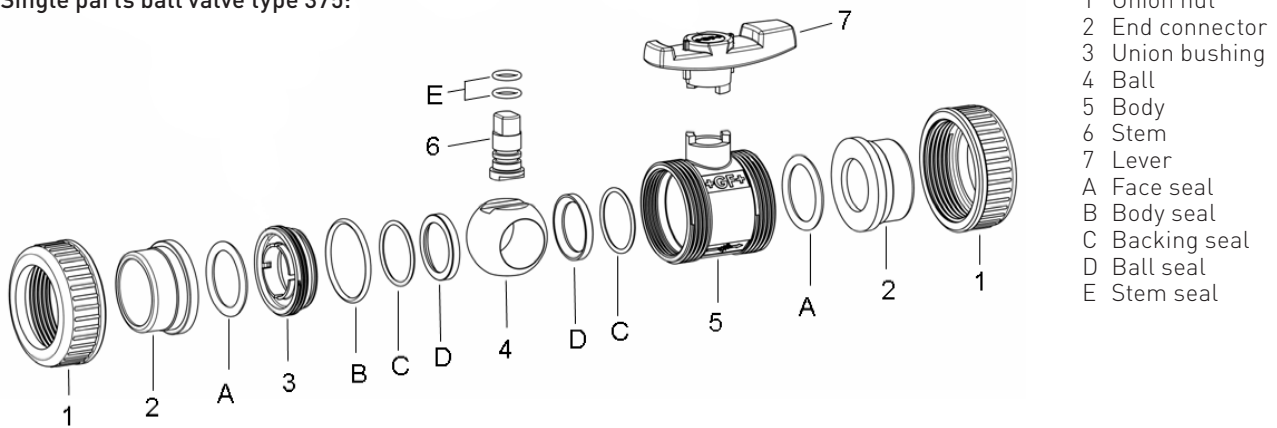

Max working pressure:

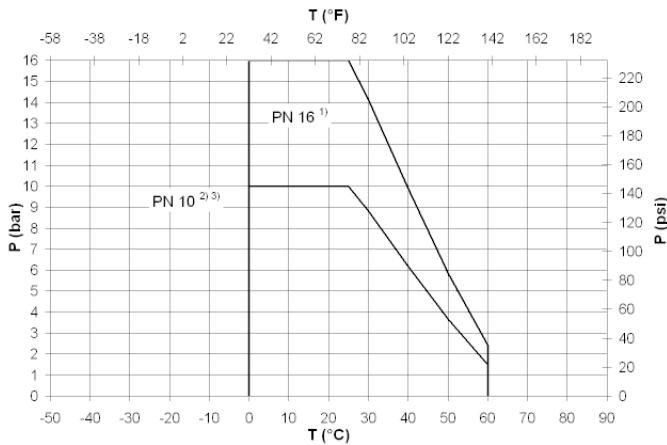

Comments:

The pressure-temperature diagrams are based on a service life of 25 years and apply to water or similar media.

- 1) For nominal dimensions of DN10 - DN50, the central body of the ball valve is designed for nominal pressure PN16
- 2) For nominal dimensions of DN65 - DN100, the central body of the ball valve is designed for nominal pressure PN10
- 3) Depending on the end connection, at nominal dimensions of DN10 - DN50, the nominal pressure reduces to PN10

p permissible operating pressure in bar, psi

T Temperature in °C, °F

Torque:

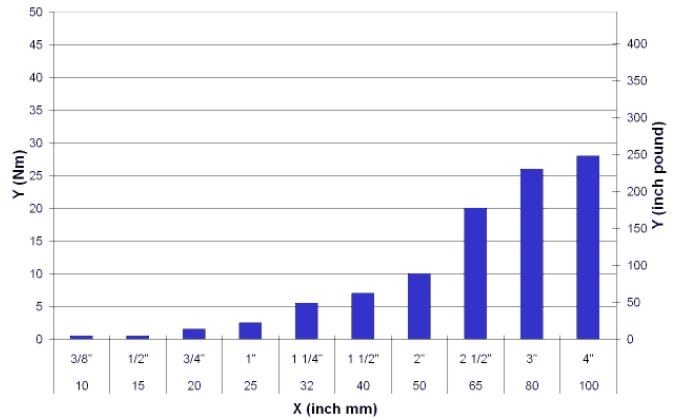

X Nominal width DN (mm, inch)

Y Torque (Nm, inch pound)

Guide values at nominal pressure

Pressure loss:

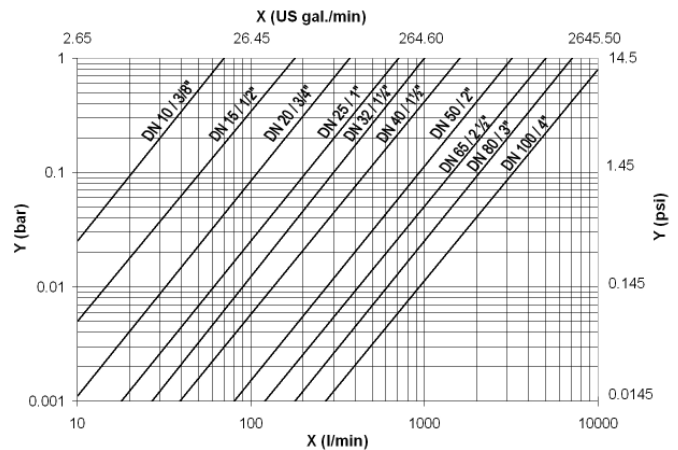

Medium: Water, 20 °C

X flow rate l/min), (US gal./min)

Y pressure loss  $\Delta p$  (bar), (psi)

# PVC-U metric

## Ball valve type 375 PVC-U With solvent cement sockets metric

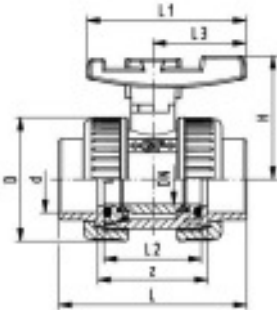

### Range of use

- Basic applications of the water treatment sector as well as other applications involving water.

### Model:

- For easy installation and removal
- z-dimension, valve end and valve nut are not compatible with type 546
- Ball seals PTFE
- Actuator unit not connectable

d [mm]	DN [mm]	PN	kv-value ( $\Delta p=1$ bar) [l/min]	EPDM Code	FPM Code	kg
16	10	16	71	<b>161 375 501</b>	<b>161 375 511</b>	0.130
20	15	16	185	<b>161 375 502</b>	<b>161 375 512</b>	0.130
25	20	16	350	<b>161 375 503</b>	<b>161 375 513</b>	0.210
32	25	16	700	<b>161 375 504</b>	<b>161 375 514</b>	0.310
40	32	16	1000	<b>161 375 505</b>	<b>161 375 515</b>	0.450
50	40	16	1600	<b>161 375 506</b>	<b>161 375 516</b>	0.690
63	50	16	3100	<b>161 375 507</b>	<b>161 375 517</b>	1.200
75	65	10	5000	<b>161 375 508</b>	<b>161 375 518</b>	2.190
90	80	10	7000	<b>161 375 509</b>	<b>161 375 519</b>	3.360
110	100	10	11000	<b>161 375 510</b>	<b>161 375 520</b>	6.060

d [mm]	D [mm]	H [mm]	L [mm]	L1 [mm]	L2 [mm]	L3 [mm]	z [mm]
16	50	53	76	60	42	40	48
20	50	53	80	60	42	40	48
25	59	60	91	65	48	45	53
32	68	67	102	75	54	51	58
40	80	79	120	85	62	59	68
50	94	90	140	95	72	70	78
63	115	107	169	110	86	84	93
75	145	129	206	130	110	103	118
90	168	143	242	140	128	120	140
110	210	169	282	160	150	141	160



## Ball valve type 375 PVC-U With threaded sockets Rp



### Range of use

- Basic applications of the water treatment sector as well as other applications involving water.

### Model:

- For easy installation and removal
- z-dimension, valve end and valve nut are not compatible with type 546
- Ball seals PTFE
- Actuator unit not connectable

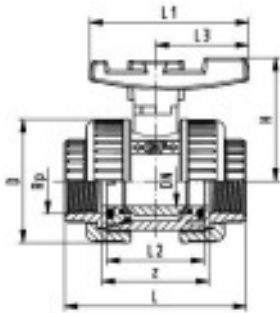

Rp [inch]	DN [mm]	PN	kv-value ( $\Delta p=1$ bar) [l/min]	EPDM Code	FPM Code	kg	
3/8	10	10	71	<b>161 375 521</b>	<b>161 375 531</b>	0.130	
1/2	15	10	185	<b>161 375 522</b>	<b>161 375 532</b>	0.130	
3/4	20	10	350	<b>161 375 523</b>	<b>161 375 533</b>	0.210	
1	25	10	700	<b>161 375 524</b>	<b>161 375 534</b>	0.300	
1 1/4	32	10	1000	<b>161 375 525</b>	<b>161 375 535</b>	0.450	
1 1/2	40	10	1600	<b>161 375 526</b>	<b>161 375 536</b>	0.680	
2	50	10	3100	<b>161 375 527</b>	<b>161 375 537</b>	1.190	
2 1/2	65	10	5000	<b>161 375 528</b>	<b>161 375 538</b>	2.150	
3	80	10	7000	<b>161 375 529</b>	<b>161 375 539</b>	3.300	
4	100	10	11000	<b>161 375 530</b>	<b>161 375 540</b>	5.890	

Rp [inch]	D [mm]	H [mm]	L [mm]	L1 [mm]	L2 [mm]	L3 [mm]	z [mm]	
3/8	50	53	76	60	42	40	48	
1/2	50	53	80	60	42	40	48	
3/4	59	60	91	65	48	45	53	
1	68	67	102	75	54	51	58	
1 1/4	80	79	116	85	62	59	68	
1 1/2	94	90	126	95	72	70	78	
2	115	107	149	110	86	84	93	
2 1/2	145	129	184	130	110	103	118	
3	168	143	212	140	128	120	140	
4	210	169	244	160	150	141	160	

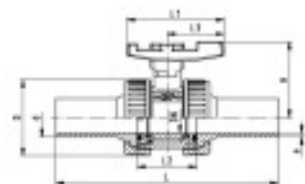

## Ball valve type 375 PVC-U With butt fusion spigots long PE 100 SDR11 metric



### Range of use

- Basic applications of the water treatment sector as well as other applications involving water.

### Model:

- For easy installation and removal
- z-dimension, valve end and valve nut are not compatible with type 546
- Ball seals PTFE
- Actuator unit not connectable

d [mm]	DN [mm]	PN	kv-value ( $\Delta p=1$ bar) [l/min]	EPDM Code	FPM Code	kg
20	15	16	185	<b>161 375 542</b>	<b>161 375 552</b>	0.150
25	20	16	350	<b>161 375 543</b>	<b>161 375 553</b>	0.210
32	25	16	700	<b>161 375 544</b>	<b>161 375 554</b>	0.310
40	32	16	1000	<b>161 375 545</b>	<b>161 375 555</b>	0.450
50	40	16	1600	<b>161 375 546</b>	<b>161 375 556</b>	1.000
63	50	16	3100	<b>161 375 547</b>	<b>161 375 557</b>	1.260
75	65	10	5000	<b>161 375 548</b>	<b>161 375 558</b>	2.400
90	80	10	7000	<b>161 375 549</b>	<b>161 375 559</b>	3.630
110	100	10	11000	<b>161 375 550</b>	<b>161 375 560</b>	6.420

d [mm]	D [mm]	H [mm]	L [mm]	L1 [mm]	L2 [mm]	L3 [mm]	e [mm]
20	95	53	175	60	42	40	1.8
25	105	60	195	65	48	45	2.3
32	115	67	247	75	54	51	2.9
40	140	79	233	85	62	59	3.6
50	150	90	265	95	72	70	4.5
63	165	107	278	110	86	84	5.7
75	185	129	348	130	110	103	6.8
90	200	143	350	140	128	120	8.2
110	220	169	412	160	150	141	10.0





## Ball valve type 375 PVC-U With PVC-U fixed flanges serrated metric



### Range of use

- Basic applications of the water treatment sector as well as other applications involving water.

### Model:

- For easy installation and removal
- z-dimension, valve end and valve nut are not compatible with type 546
- Ball seals PTFE
- Actuator unit not connectable
- Overall length according to EN 558-1
- Connecting dimension: ISO 7005 PN10, EN 1092 PN10, DIN 2501 PN10

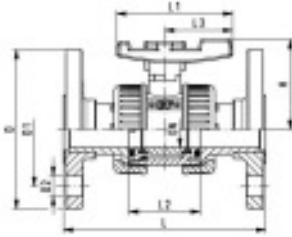

d [mm]	DN [mm]	PN	kv-value ( $\Delta p=1$ bar) [l/min]	EPDM Code	FPM Code	kg
20	15	16	185	<b>161 375 562</b>	<b>161 375 572</b>	0.270
25	20	16	350	<b>161 375 563</b>	<b>161 375 573</b>	0.430
32	25	16	700	<b>161 375 564</b>	<b>161 375 574</b>	0.620
40	32	16	1000	<b>161 375 565</b>	<b>161 375 575</b>	0.920
50	40	16	1600	<b>161 375 566</b>	<b>161 375 576</b>	1.300
63	50	16	3100	<b>161 375 567</b>	<b>161 375 577</b>	2.100
75	65	10	5000	<b>161 375 568</b>	<b>161 375 578</b>	3.400
90	80	10	7000	<b>161 375 569</b>	<b>161 375 579</b>	4.950
110	100	10	11000	<b>161 375 570</b>	<b>161 375 580</b>	8.290

d [mm]	D [mm]	D1 [mm]	D2 [mm]	H [mm]	L [mm]	L1 [mm]	L2 [mm]	L3 [mm]
20	95	65	14	53	130	60	42	40
25	105	75	14	60	150	65	48	45
32	115	85	14	67	160	75	54	51
40	140	100	18	79	180	85	62	59
50	150	110	18	90	200	95	72	70
63	165	125	18	107	230	110	86	84
75	185	145	18	129	290	130	110	103
90	200	160	18	143	310	140	128	120
110	220	180	18	169	350	160	150	141

# PVC-U Inch BS

## Ball valve type 375 PVC-U With solvent cement sockets Inch BS

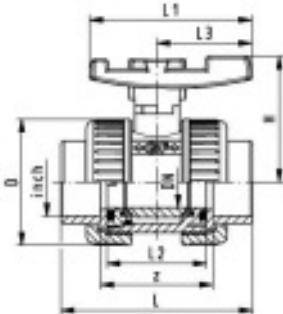

### Range of use

- Basic applications of the water treatment sector as well as other applications involving water.

### Model:

- For easy installation and removal
- z-dimension, valve end and valve nut are not compatible with type 546
- Ball seals PTFE
- Actuator unit not connectable

Inch	DN [mm]	PN	kv-value ( $\Delta p=1$ bar) [l/min]	EPDM Code	FPM Code	kg	
3/8	10	16	71	<b>161 375 601</b>	<b>161 375 611</b>	0.130	
1/2	15	16	185	<b>161 375 602</b>	<b>161 375 612</b>	0.130	
3/4	20	16	350	<b>161 375 603</b>	<b>161 375 613</b>	0.210	
1	25	16	700	<b>161 375 604</b>	<b>161 375 614</b>	0.310	
1 1/4	32	16	1000	<b>161 375 605</b>	<b>161 375 615</b>	0.450	
1 1/2	40	16	1600	<b>161 375 606</b>	<b>161 375 616</b>	0.690	
2	50	16	3100	<b>161 375 607</b>	<b>161 375 617</b>	1.200	
	65	10	5000	<b>161 375 508</b>	<b>161 375 518</b>	2.190	
	80	10	7000	<b>161 375 609</b>	<b>161 375 619</b>	3.360	
4	100	10	11000	<b>161 375 610</b>	<b>161 375 620</b>	6.060	

Inch	D [mm]	H [mm]	L [mm]	L1 [mm]	L2 [mm]	L3 [mm]	z [mm]
3/8	50	53	76	60	42	40	48
1/2	50	53	80	60	42	40	48
3/4	59	60	91	65	48	45	53
1	68	67	102	75	54	51	58
1 1/4	80	79	120	85	62	59	68
1 1/2	94	90	140	95	72	70	78
2	115	107	169	110	86	84	93
	145	129	206	130	110	103	118
3	168	143	242	140	128	120	140
4	210	169	282	160	150	141	160

# PVC-U ASTM/ANSI

## Ball valve type 375 PVC-U With solvent cement sockets Inch ASTM Inclusive 2 threaded valve ends NPT

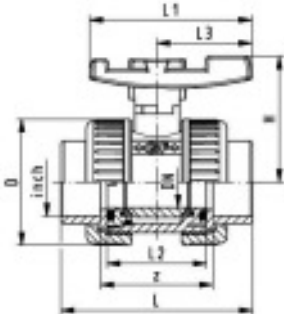

### Range of use

- Basic applications of the water treatment sector as well as other applications involving water.

### Model:

- For easy installation and removal
- z-dimension, valve end and valve nut are not compatible with type 546
- Ball seals PTFE
- Actuator unit not connectable
- Threaded valve ends are only enclosed for DN10/15-50

Inch	DN [mm]	PN	kv-value ( $\Delta p=1$ bar) [l/min]	EPDM Code	FPM Code	kg
3/8	10	16	71	<b>161 375 001</b>	<b>161 375 016</b>	0.130
1/2	15	16	185	<b>161 375 002</b>	<b>161 375 017</b>	0.130
3/4	20	16	350	<b>161 375 003</b>	<b>161 375 018</b>	0.210
1	25	16	700	<b>161 375 004</b>	<b>161 375 019</b>	0.310
1 1/4	32	16	1000	<b>161 375 005</b>	<b>161 375 020</b>	0.450
1 1/2	40	16	1600	<b>161 375 006</b>	<b>161 375 021</b>	0.690
2	50	16	3100	<b>161 375 007</b>	<b>161 375 022</b>	1.200
2 1/2	65	10	5000	<b>161 375 008</b>	<b>161 375 023</b>	2.190
3	80	10	7000	<b>161 375 009</b>	<b>161 375 024</b>	3.360
4	100	10	11000	<b>161 375 010</b>	<b>161 375 025</b>	6.060

Inch	D [mm]	H [mm]	L [mm]	L1 [mm]	L2 [mm]	L3 [mm]	z [mm]
3/8	50	53	76	60	42	40	48
1/2	50	53	80	60	42	40	48
3/4	59	60	91	65	48	45	53
1	68	67	102	75	54	51	58
1 1/4	80	79	120	85	62	59	68
1 1/2	94	90	140	95	72	70	78
2	115	107	169	110	86	84	93
2 1/2	145	129	206	130	110	103	118
3	168	143	242	140	128	120	140
4	210	169	282	160	150	141	160

# Valve ends ball valve type 375

## Valve end 375 PVC-U With solvent cement socket metric



Available from 2nd quarter 2007

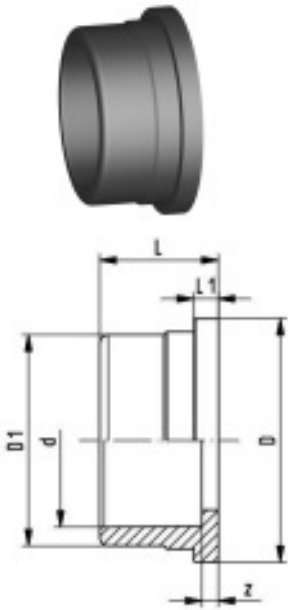

d [mm]	DN [mm]	PN	Code	D [mm]	D1 [mm]	L [mm]	L1 [mm]	z [mm]
16	10	16	<b>161 375 901</b>	35	26	18	5	4
20	15	16	<b>161 375 902</b>	35	29	18	5	2
25	20	16	<b>161 375 903</b>	43	35	21	5	2
32	25	16	<b>161 375 904</b>	51	43	24	6	2
40	32	16	<b>161 375 905</b>	60	52	29	6	3
50	40	16	<b>161 375 906</b>	72	62	34	7	3
63	50	16	<b>161 375 907</b>	89	76	41	7	3
75	65	10	<b>161 375 908</b>	115	90	47	8	3
90	80	10	<b>161 375 909</b>	133	106	56	10	5
110	100	10	<b>161 375 910</b>	166	130	66	12	5

## Valve end 375 PVC-U With solvent cement socket BS



Available from 2nd quarter 2007



Inch	PN	Code	D [mm]	D1 [mm]	L [mm]	L1 [mm]	z [mm]
3/8	16	<b>161 375 911</b>	35	26	18	5	4
1/2	16	<b>161 375 912</b>	35	29	18	5	2
3/4	16	<b>161 375 913</b>	43	35	21	5	2
1	16	<b>161 375 914</b>	51	43	24	6	2
1 1/4	16	<b>161 375 915</b>	60	52	29	6	2
1 1/2	16	<b>161 375 916</b>	72	62	34	7	3
2	16	<b>161 375 917</b>	89	76	41	7	3
	10	<b>161 375 908</b>	115	90	47	8	
3	10	<b>161 375 919</b>	133	106	56	10	5
4	10	<b>161 375 920</b>	166	131	66	12	5



## Valve end 375 PVC-U With solvent cement socket ASTM



Available from 2nd quarter 2007

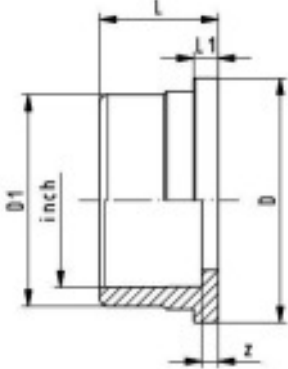

Inch	PN	Code	D [mm]	D1 [mm]	L [mm]	L1 [mm]	z [mm]
3/8	16	<b>161 375 427</b>	35	26	23	5	4
1/2	16	<b>161 375 428</b>	35	29	25	5	2
3/4	16	<b>161 375 429</b>	43	35	28	5	2
1	16	<b>161 375 430</b>	51	43	31	6	2
1 1/4	16	<b>161 375 431</b>	60	53	34	6	2
1 1/2	16	<b>161 375 432</b>	72	62	38	7	3
2	16	<b>161 375 433</b>	89	76	41	7	3
2 1/2	10	<b>161 375 434</b>	114	90	48	8	3
3	10	<b>161 375 435</b>	133	106	57	10	8
4	10	<b>161 375 436</b>	165	130	66	12	5



## Valve end 375 PVC-U With threaded socket Rp



Model:

- Connection to plastic thread only
- Do not use thread sealing pastes that are harmful to PVC-U

Available from 2nd quarter 2007

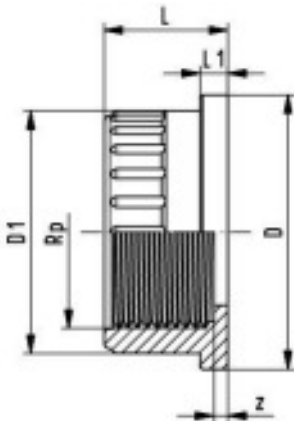

Rp [inch]	PN	Code	D [mm]	D1 [mm]	L [mm]	L1 [mm]	z [mm]
3/8	10	<b>161 375 921</b>	35	26	18	5	7
1/2	10	<b>161 375 922</b>	33	30	18	5	3
3/4	10	<b>161 375 923</b>	43	36	21	5	5
1	10	<b>161 375 924</b>	51	44	24	6	5
1 1/4	10	<b>161 375 925</b>	60	53	27	6	6
1 1/2	10	<b>161 375 926</b>	72	63	27	7	6
2	10	<b>161 375 927</b>	89	77	31	7	5
2 1/2	10	<b>161 375 928</b>	115	90	36	8	6
3	10	<b>161 375 929</b>	133	106	41	10	8
4	10	<b>161 375 930</b>	166	130	47	12	8



## Valve end 375 PVC-U With threaded socket NPT



### Model:

- Connection to plastic thread only
- Do not use thread sealing pastes that are harmful to PVC-U

Available from 2nd quarter 2007

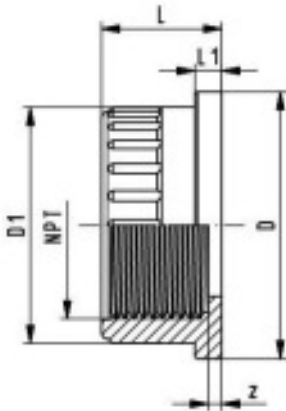

NPT [inch]	PN	Code	D [mm]	D1 [mm]	L [mm]	L1 [mm]	z [mm]
3/8	10	<b>161 375 437</b>	35	26	18	5	5
1/2	10	<b>161 375 438</b>	35	30	24	5	6
3/4	10	<b>161 375 439</b>	43	36	21	5	5
1	10	<b>161 375 440</b>	51	44	24	6	5
1 1/4	10	<b>161 375 441</b>	60	53	27	6	6
1 1/2	10	<b>161 375 442</b>	72	64	27	7	6
2	10	<b>161 375 443</b>	89	77	31	7	5



## Valve end 375 PVC-U With butt fusion spigot long SDR11 metric



Available from 2nd quarter 2007

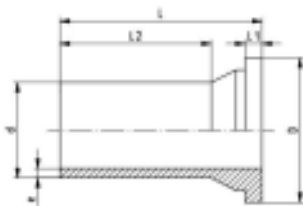

d [mm]	PN	Code	D [mm]	e [mm]	L [mm]	L1 [mm]	L2 [mm]
20	16	<b>161 375 932</b>	36	3.5	67	6	45
25	16	<b>161 375 933</b>	44	3.5	74	6	50
32	16	<b>161 375 934</b>	52	3.5	97	7	72
40	16	<b>161 375 935</b>	61	4.0	86	7	63
50	16	<b>161 375 936</b>	73	5.0	97	8	72
63	16	<b>161 375 937</b>	90	6.2	96	9	75
75	16	<b>161 375 938</b>	116	7.0	119	10	88
90	16	<b>161 375 939</b>	134	9.0	112	12	82
110	16	<b>161 375 940</b>	168	10.0	131	15	96

## Spare parts

### Handle to type 375 PVC-U Standard handle, orange

Available from 2nd quarter 2007

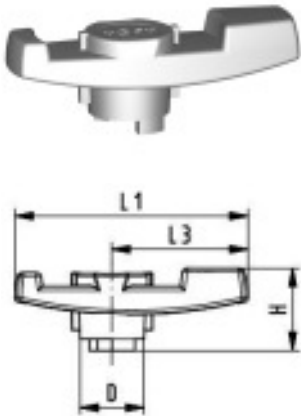

d-d [mm]	DN-DN [mm]	Code	L1 [mm]	L3 [mm]	H [mm]	D [mm]
16 - 20	10 - 15	<b>161 490 900</b>	67	40	27	19
- 25	- 20	<b>161 490 901</b>	77	45	28	22
- 32	- 25	<b>161 490 902</b>	87	51	32	25
- 40	- 32	<b>161 490 903</b>	102	59	36	28
- 50	- 40	<b>161 490 904</b>	119	70	40	32
- 63	- 50	<b>161 490 905</b>	146	84	45	37
- 75	- 65	<b>161 490 906</b>	179	103	52	41
- 90	- 80	<b>161 490 907</b>	209	120	57	44
- 110	- 100	<b>161 490 908</b>	250	141	61	48

### Seal set 375 PVC-U

#### Model:

- Consisting of ball seals PTFE and o-rings

Available from 2nd quarter 2007



d [mm]	DN [mm]	EPDM Code	FPM Code
16	10	<b>161 375 402</b>	<b>161 375 417</b>
20	15	<b>161 375 403</b>	<b>161 375 418</b>
25	20	<b>161 375 404</b>	<b>161 375 419</b>
32	25	<b>161 375 405</b>	<b>161 375 420</b>
40	32	<b>161 375 406</b>	<b>161 375 421</b>
50	40	<b>161 375 407</b>	<b>161 375 422</b>
63	50	<b>161 375 408</b>	<b>161 375 423</b>
63	65	<b>161 375 409</b>	<b>161 375 424</b>
90	80	<b>161 375 410</b>	<b>161 375 425</b>
110	100	<b>161 375 411</b>	<b>161 375 426</b>









# General Condition of Supply of Georg Fischer Piping Systems Limited, Schaffhausen

## 1 General

- 1.1 These General Conditions shall apply to all Products supplied by Georg Fischer to the Purchaser. They shall also apply to all future business even when no express reference is made to them.
- 1.2 Any deviating or supplementary conditions especially Purchaser's general conditions of purchase and verbal agreements shall only be applicable if accepted in writing by Georg Fischer.
- 1.3 The written form shall be deemed to be fulfilled by all forms of transmission, evidenced in the form of text, such as telefax, e-mail, etc.

## 2 Tenders

- Tenders shall only be binding if they contain a specifically stated period for acceptance.

## 3 Scope of Delivery

- 3.1 Georg Fischer's product range is subject to change.
- 3.2 The confirmation of order shall govern the scope and execution of the contract.

## 4 Data and Documents

- 4.1 Technical documents such as drawings, descriptions, illustrations and data on dimensions, performance and weight as well as the reference to standards are for information purposes only. They are not warranted characteristics and are subject to change.
- 4.2 All technical documents shall remain the exclusive property of Georg Fischer and may only be used for the agreed purposes or as Georg Fischer may consent.

## 5 Confidentiality, Protection of Personal Data

- 5.1 Each party shall keep in strict confidence all commercial or technical information relating to the business of the other party, of which it has gained knowledge in the course of its dealing with the other party. Such information shall neither be disclosed to third parties nor used for other purposes than those for which the information has been supplied.
- 5.2 In the context of the contractual relation with the Purchaser personal data may be processed. The Purchaser agrees to the disclosure of said data to third parties such as foreign subcontractors and suppliers etc.

## 6 Local Laws and Regulations, Export Controls

- 6.1 The Purchaser shall bring to the attention of Georg Fischer all local laws and regulations at the place of destination which bear connection with the execution of the contract and the adherence to relevant safety regulations and approval procedures.
- 6.2 In case of re-exports, Purchaser shall be responsible for compliance with pertinent export control regulations.

## 7 Price

- 7.1 Unless agreed otherwise, the prices shall be deemed quoted net ex works (according to Incoterms of the ICC, latest version) including standard packing. All supplementary costs such as the cost of carriage, insurance, export-, transit- and importlicences etc. shall be borne by the Purchaser. The Purchaser shall also bear the costs of all taxes, fees, duties etc. connected with the contract.
- 7.2 If the costs of packing, carriage, insurance, fees and other supplementary costs are included in the tender price or contract price or are referred to specifically in the tender or confirmation of order, Georg Fischer reserve the right to revise their prices accordingly should any change occur in the relevant tariffs.

## 8 Terms of Payment

- 8.1 The Purchaser shall make payment in the manner agreed by the parties without any deductions such as discounts, costs, taxes or dues.
- 8.2 The Purchaser may only withhold or off-set payments due against counter claims which are either expressly acknowledged by Georg Fischer or finally awarded to the Purchaser. In particular, payment shall still be made when unessential items are still out-standing provided that the Products already delivered are not rendered unusable as a result.

## 9 Retention of Title

- 9.1 The Products shall remain the property of Georg Fischer until the Purchaser shall have settled all claims, present and future, which Georg Fischer may have against him.
- 9.2 Should the Purchaser resell Products to which title is reserved, in the ordinary course of business, he shall hereby be deemed to have tacitly assigned to Georg Fischer the proceeds deriving from their sale together with all collateral rights, securities and reservations of title until all claims held by Georg Fischer shall have been settled. Until revoked by Georg Fischer, this assignment shall not preclude Purchaser's right to collect the assigned receivables.
- 9.3 To the extent the value of the Products to which title is reserved together with collateral securities exceeds Georg Fischer's claims against the Purchaser by more than 20%, Georg Fischer shall re-assign the above proceeds to Purchaser at his request.

## 10 Delivery

- 10.1 The term of delivery shall commence as soon as the contract has been entered into, all official formalities such as import and payment permits have been obtained and all essential technical issues have been settled. The term of delivery shall be deemed duly observed when, upon its expiry, the Products are ready for despatch.
- 10.2 Delivery is subject to the following conditions, i.e. the term of delivery shall be reasonably extended:
  - a) if Georg Fischer are not supplied in time with the information necessary for the execution of the contract or if subsequent changes causing delays are made by the Purchaser.
  - b) if Georg Fischer are prevented from performing the contract by force majeure. Force majeure shall equally be deemed to be any unforeseeable event beyond Georg Fischer's control which renders Georg Fischer's performance commercially unpractical or impossible, such as delayed or defective supplies from sub contractors labour disputes, governmental orders or regulations, shortages in materials or energy, serious disturbances in Georg Fischer's works, such as the total or partial destruction of plant and equipment or the breakdown of essential facilities, serious disruptions in transport facilities, e.g. impassable roads.  
Should the effect of force majeure exceed a period of six months, either party may cancel the contract forthwith.  
Georg Fischer shall not be liable for any damage or loss of any kind whatsoever resulting therefrom, any suspension or cancellation being without prejudice to Georg Fischer's right to recover all sums due in respect of consignments delivered and costs incurred to date.
  - c) if the Purchaser is in delay with the fulfilment of his obligations under the contract, in particular, if he does not adhere to the agreed conditions of payment or if he has failed to timely provide the agreed securities.
- 10.3 If for reasons attributable to Georg Fischer the agreed term of delivery or a reasonable extension thereof is exceeded, Georg Fischer shall not be deemed in default until the Purchaser has granted to Georg Fischer in writing a reasonable extension thereof of not less than one month which equally is not met.  
The Purchaser shall then be entitled to the remedies provided at law, it being however understood that, subject to limitations of Art. 16, damage claims shall be limited to max. 10% of the price of the delayed delivery.
- 10.4 Part shipments shall be allowed and Georg Fischer shall be entitled to invoice for such partial deliveries.
- 10.5 If the Purchaser fails to take delivery within a reasonable time of Products notified as ready for despatch, Georg Fischer shall be entitled to store the Products at the Purchaser's expense and risk and to invoice them as delivered. If Purchaser fails to effect payment, Georg Fischer shall be entitled to dispose of the Products.
- 10.6 Should Purchaser cancel an order without justification and should Georg Fischer not insist on the performance of the contract, Georg Fischer shall be entitled to liquidated damages in the amount of 10% of the contract price, Georg Fischer's right to prove and claim higher damages remaining reserved. Purchaser shall be entitled to prove, that Georg Fischer has suffered no or a considerably lower damage.

## 11 Packing

- If the Products are provided with additional packing over and above the standard packing, such packing shall be charged additionally.

## 12 Passing of Risk

- 12.1 The risk in the Products shall pass to the Purchaser as soon as they have left Georg Fischer's works (EX WORKS, Incoterms ICC, latest version), even if delivery is made carriage-paid, under similar clauses or including installation or when carriage is organized and managed by Georg Fischer.
- 12.2 If delivery is delayed for reasons beyond Georg Fischer's control, the risk shall pass to the Purchaser when he is notified that the Products are ready for despatch.

## 13 Carriage and Insurance

- 13.1 Unless agreed otherwise, the Purchaser shall bear the cost of carriage.
- 13.2 The Purchaser shall be responsible for transport insurance against damage of whatever kind. Even when such insurance is arranged by Georg Fischer it shall be deemed taken out by the order of and for the account of the Purchaser and at his risk.
- 13.3 Special requests regarding carriage and insurance shall be communicated to Georg Fischer in due time. Otherwise carriage shall be arranged by Georg Fischer at their discretion, but without responsibility, by the quickest and cheapest method possible.  
In case of carriage-paid delivery transport arrangements shall be made by Georg Fischer. If the Purchaser specifies particular requirements, any extra costs involved shall be borne by him.
- 13.4 In the event of damage or loss of the Products during carriage the Purchaser shall mark the delivery documents accordingly and immediately have the damage ascertained by the carrier. Not readily ascertainable damages sustained during carriage shall be notified to the carrier within six days after receipt of the Products.

## 14 Inspection, Notification of Defects and Damages

- 14.1 The Products will be subject to normal inspection by Georg Fischer during manufacture. Additional tests required by the Purchaser shall be agreed upon in writing and shall be charged to the Purchaser.
- 14.2 It shall be a condition of Georg Fischer's obligation under the warranties stated hereinafter that Georg Fischer be notified in writing by the Purchaser of any purported defect immediately upon discovery. Notice concerning weight, numbers or apparent defects is to be given latest within 30 days from receipt of the Products, notice of other defects immediately latest within 7 working days after discovery, in any event within the agreed warranty period.
- 14.3 Purchaser shall not dispose of allegedly defective Products until all warranty and/or damage claims are finally settled. At its request, defective Products are to be placed at Georg Fischer's disposal.
- 14.4 At its request, Georg Fischer shall be given the opportunity to inspect the defect and/or damage, prior to commencement of remedial work, either itself or by third party experts.

## 15 Warranty

- 15.1 At the written request of the Purchaser, Georg Fischer undertake to repair or replace at their discretion, as quickly as possible and free of charge all Products supplied which demonstrably suffer from faulty design, materials or workman-ship or from faulty operating or installation instructions.  
In order to protect employees from toxic or radioactive substances which may have been transported through defective parts returned to Georg Fischer's sales organisation, said parts must be accompanied by a Material Safety Disclosure Form. The form may be obtained from Georg Fischer's local sales company or via [www.piping.georgfischer.com](http://www.piping.georgfischer.com).  
Replaced parts shall become property of Georg Fischer.
- 15.2 For Products which are manufactured to specifications, drawings or patterns supplied by the Purchaser, Georg Fischer's warranty shall be restricted to proper materials and workmanship.
- 15.3 The Purchaser shall be entitled to cancel the contract or to demand a reduction in the contract price if also a second attempt to repair or replace the Products has failed.
- 15.4 For Products or essential components manufactured by a third party and supplied by Georg Fischer under this contract, Georg Fischer's warranty is limited to the warranty provided by said third party.
- 15.5 This warranty shall not apply to damage resulting from normal wear and tear, improper storage and maintenance, failure to observe the operating instructions, overstressing or overloading, unsuitable operating media, unsuitable construction work or unsuitable building ground, improper repairs or alterations by the Purchaser or third parties, the use of other than original spare parts and other reasons beyond Georg Fischer's control.
- 15.6 No action or claim may be brought by the Purchaser on account of any alleged breach of warranty or any other obligation of Georg Fischer after the expiration of twelve (12) months from receipt of the Products by the end user or at the latest within eighteen (18) months of the Products being despatched by Georg Fischer.
- 15.7 In case of Products for use in domestic installations or in utilities
  - Georg Fischer will assume the costs of dismantling the defective Product and restoring the damaged object as well as, in case of negligence, all other direct damages caused by the defective Product (damage to property and injury to or death of persons) up to CHF 1 000 000 per occurrence.
  - the statute of limitations for warranty or damage claims - contrary to Section 15.6 - will be 5 years from the date of installation.

## 16 Limitation of Liability

- All cases of breach of contract and the relevant consequences as well as all rights and claims on the part of the customer, irrespective on what ground they are based, are exhaustively covered by these general conditions of supply. In particular, any claims not expressly mentioned for damages, reduction of price, termination of or withdrawal from the contract are excluded. In no case whatsoever shall the customer be entitled to claim damages other than compensation for costs of remedying defects in the supplies. This in particular refers, but shall not be limited, to loss of production, loss of use, loss of orders, loss of profit and other direct or indirect or consequential damage. This exclusion of liability, however, does not apply to unlawful intent or gross negligence on the part of Georg Fischer and in case of strict liability under applicable product liability statutes, but does apply to unlawful intent or gross negligence of persons employed or appointed by Georg Fischer to perform any of its obligations.

## 17 Severability

- Should any term or clause of these General Conditions in whole or in part be found to be unenforceable or void, all other provisions shall remain in full force and effect and the unenforceable or void provision shall be replaced by a valid provision, which comes closest to the original intention of the unenforceable or invalid provision.

## 18 Place of Performance and Jurisdiction

- 18.1 Place of performance for the Products shall be the Georg Fischer works from which the Products are despatched.
- 18.2 Any civil action based upon any alleged breach of this contract shall be filed and prosecuted exclusively in the courts of Schaffhausen, Switzerland.  
Georg Fischer however reserves the right to file actions in any court having jurisdiction over controversies arising out of or in connection with the present contract.
- 18.3 The contract shall be governed by Swiss law without regard to conflict of law provisions that would require the application of another law.

# GF Piping Systems → worldwide at home

Our sales companies and representatives ensure local customer support in over 100 countries.

[www.piping.georgfischer.com](http://www.piping.georgfischer.com)



The technical data are not binding and not expressly warranted characteristics of the goods. They are subject to change. Our General Conditions of Sale apply.

## Adding Quality to People's Lives

### Australia

Georg Fischer Pty Ltd  
Unit 1, 100 Belmore Road  
Riverwood NSW 2210 Australia  
Phone +61(0)2/9502 8000  
[australia.ps@georgfischer.com](mailto:australia.ps@georgfischer.com)  
[www.georgfischer.com.au](http://www.georgfischer.com.au)

### Austria

Georg Fischer  
Rohrleitungssysteme GmbH  
3130 Herzogenburg  
Phone +43(0)2782/856 43-0  
[austria.ps@georgfischer.com](mailto:austria.ps@georgfischer.com)  
[www.georgfischer.at](http://www.georgfischer.at)

### Belgium/Luxembourg

Georg Fischer NV/SA  
1070 Bruxelles/Brüssel  
Phone +32(0)2/556 40 20  
[be.ps@georgfischer.com](mailto:be.ps@georgfischer.com)  
[www.georgfischer.be](http://www.georgfischer.be)

### Brazil

Georg Fischer Ltda  
04795-100 São Paulo  
Phone +55(0)11/5687 1311  
[br.ps@georgfischer.com](mailto:br.ps@georgfischer.com)

### China

Georg Fischer  
Piping Systems Ltd Shanghai  
Pudong, Shanghai 201319  
Phone +86(0)21/58 13 33 33  
[china.ps@georgfischer.com](mailto:china.ps@georgfischer.com)  
[www.cn.piping.georgfischer.com](http://www.cn.piping.georgfischer.com)

### Denmark/Iceland

Georg Fischer A/S  
2630 Taastrup  
Phone +45 (0)70 22 19 75  
[info.dk.ps@georgfischer.com](mailto:info.dk.ps@georgfischer.com)  
[www.georgfischer.dk](http://www.georgfischer.dk)

### France

Georg Fischer SAS  
Bâtiment Le Rabelais Paris Nord 2  
22 Avenue des Nations  
BP 88026 Villepinte  
95932 Roissy Charles de Gaulle Cedex  
Phone +33(0)1 41 84 68 84  
[fr.ps@georgfischer.com](mailto:fr.ps@georgfischer.com)  
[www.georgfischer.fr](http://www.georgfischer.fr)

### Germany

Georg Fischer GmbH  
73095 Albershausen  
Phone +49(0)7161/302-0  
[info.de.ps@georgfischer.com](mailto:info.de.ps@georgfischer.com)  
[www.vgd.georgfischer.de](http://www.vgd.georgfischer.de)

### India

Georg Fischer Piping Systems Ltd  
400 076 Mumbai  
Phone +91 224007 2001  
[in.ps@georgfischer.com](mailto:in.ps@georgfischer.com)  
[www.georgfischer.in](http://www.georgfischer.in)

### Italy

Georg Fischer S.p.A.  
20063 Cernusco S/N (MI)  
Phone +3902/921 861  
[it.ps@georgfischer.com](mailto:it.ps@georgfischer.com)  
[www.georgfischer.it](http://www.georgfischer.it)

### Japan

Georg Fischer Ltd  
556-0011 Osaka,  
Phone +81(0)6/6635 2691  
[jp.ps@georgfischer.com](mailto:jp.ps@georgfischer.com)  
[www.georgfischer.jp](http://www.georgfischer.jp)

### Korea

Georg Fischer Piping Systems  
#902 Ace Techno-Tower III  
197-48, Guro-dong, Guro-gu  
Seoul 152-050 Korea  
Phone +82 2 851 3861/3862  
Fax +82 2 851 3844  
[kor.ps@georgfischer.com](mailto:kor.ps@georgfischer.com)

### Malaysia

Georg Fischer (M) Sdn. Bhd.  
47500 Subang Jaya  
Phone +60 (0)3-8024 7879  
[conne.kong@georgfischer.com.my](mailto:conne.kong@georgfischer.com.my)

### Middle East

Georg Fischer Piping Systems  
Dubai, United Arab Emirates  
Phone +971 4 289 41 20  
[gfdubai@emirates.net.ae](mailto:gfdubai@emirates.net.ae)  
[www.piping.georgfischer.com](http://www.piping.georgfischer.com)

### Netherlands

Georg Fischer N.V.  
8161 PA Epe  
Phone +31(0)578/678 222  
[nLps@georgfischer.com](mailto:nLps@georgfischer.com)  
[www.georgfischer.nl](http://www.georgfischer.nl)

### Norway

Georg Fischer AS  
1351 Rud  
Phone +47(0)67 18 29 00  
[no.ps@georgfischer.com](mailto:no.ps@georgfischer.com)  
[www.georgfischer.no](http://www.georgfischer.no)

### Poland

Georg Fischer Sp. z o.o.  
02-226 Warszawa  
Phone +48(0)22/313 10 50  
[poland.ps@georgfischer.com](mailto:poland.ps@georgfischer.com)  
[www.georgfischer.pl](http://www.georgfischer.pl)

### Romania

Georg Fischer  
Piping Systems Ltd  
020257 Bucharest - Sector 2  
Phone +40(0)21/230 53 80  
[ro.ps@georgfischer.com](mailto:ro.ps@georgfischer.com)

### Russia

Georg Fischer Piping Systems  
Office 14a, 3 Entrance, 9 Floor  
Business Center Parus  
1\* Tverskaya-Yamskaya Street, 23  
Moscow 125047  
Tel. +7 495 258 60 80  
[ru.ps@georgfischer.com](mailto:ru.ps@georgfischer.com)

### Singapore

Georg Fischer Pte Ltd  
528 872 Singapore  
Phone +65(0)67 47 06 11  
[sgp.ps@georgfischer.com](mailto:sgp.ps@georgfischer.com)  
[www.georgfischer.com.sg](http://www.georgfischer.com.sg)

### Spain/Portugal

Georg Fischer S.A.  
28046 Madrid  
Phone +34(0)91/781 98 90  
[es.ps@georgfischer.com](mailto:es.ps@georgfischer.com)  
[www.georgfischer.es](http://www.georgfischer.es)

### Sweden/Finland

Georg Fischer AB  
12523 Älvsjö-Stockholm  
Phone +46(0)8/506 775 00  
[info.se.ps@georgfischer.com](mailto:info.se.ps@georgfischer.com)  
[www.georgfischer.se](http://www.georgfischer.se)

### Switzerland

Georg Fischer  
Rohrleitungssysteme (Schweiz) AG  
8201 Schaffhausen  
Phone +41(0)52 631 30 26  
[ch.ps@georgfischer.com](mailto:ch.ps@georgfischer.com)  
[www.piping.georgfischer.ch](http://www.piping.georgfischer.ch)

### Taiwan

Georg Fischer Piping Systems  
2F, No. 88, Hsing Te Road  
San Chung City  
Taipei Hsien, Taiwan [R.O.C.]  
Phone +886 2 8512 2822  
Fax +886 2 8512 2823

### United Kingdom/Ireland

Georg Fischer Sales Limited  
Coventry, CV2 2ST  
Phone +44(0)2476 535 535  
[uk.ps@georgfischer.com](mailto:uk.ps@georgfischer.com)  
[www.georgfischer.co.uk](http://www.georgfischer.co.uk)

### USA/Canada/Latin America/Caribbean

Georg Fischer Inc.  
Tustin, CA 92780-7258  
Phone +1(714) 731 88 00  
Toll Free 800/854 40 90  
[us.ps@georgfischer.com](mailto:us.ps@georgfischer.com)  
[www.us.piping.georgfischer.com](http://www.us.piping.georgfischer.com)

### Export

Georg Fischer  
Piping Systems (Switzerland) Ltd.  
8201 Schaffhausen  
Phone +41 (0)52-631 30 26  
Fax +41 (0)52-631 28 93  
[export.ps@georgfischer.com](mailto:export.ps@georgfischer.com)  
[www.piping.georgfischer.ch](http://www.piping.georgfischer.ch)

GMST 8267/4 [01.07]

Made with MediaCockpit  
© Georg Fischer Piping Systems Ltd.  
8201 Schaffhausen/Switzerland, 2007  
Printed in Switzerland

**+GF+**

**GEORG FISCHER**  
PIPING SYSTEMS