

## Signet 515/2536 Rotor-X Flow Sensors



3-0515.090 Rev T 06/13

### Operating Instructions

#### Description

515 Sensor  
(with red cap)



8510 Integral  
Sensor



#### Operating Instructions for all versions of 515/8510 and 2536/8512

Simple to install with time-honoured reliable performance, Signet 515 and 2536 Rotor-X Paddlewheel Flow Sensors are highly repeatable, rugged sensors that offer exceptional value with little or no maintenance.

Signet 515 and 2536 sensors measure liquid flow rates in full pipes and can be used in low pressure systems.

- The many material choices including PP and PVDF make this model highly versatile and chemically compatible with many liquid process solutions.
- Sensors can be installed in DN15 to DN900 ( $\frac{1}{2}$  to 36 in.) pipes using Signet's comprehensive line of custom fittings
- These custom fittings, which include tees, saddles, and weldolets, seat the sensor to the proper insertion depth into the process flow.
- The sensors are also offered in configurations for wet-tap installation requirements.

2536 Sensor  
(with blue cap)



8512 Integral  
Sensor



#### 515/8510 Advantages:

- Flow rate range 0.3 to 6 m/s (1 to 20 ft/s)
- Installs into pipe sizes DN15 to DN900 ( $\frac{1}{2}$  to 36 in.)
- Wide Turndown Ratio of 20:1
- Sinusoidal frequency output capable of driving a self-powered flowmeter (Model 5090)
- Self-powered
- Highly repeatable output
- Chemically resistant materials
- Easy to replace rotor

#### 2536/8512 Advantages:

- Flow rate range 0.1 to 6 m/s (0.3 to 20 ft/s)
- Installs into pipe sizes DN15 to DN900 ( $\frac{1}{2}$  to 36 in.)
- Wide Turndown Ratio of 66:1
- Open-collector output
- High resolution and noise immunity
- Chemically resistant materials
- Easy to replace rotor



### Warranty Information

Refer to your local Georg Fischer Sales office for the most current warranty statement.

All warranty and non-warranty repairs being returned must include a fully completed Service Form and goods must be returned to your local GF Sales office or distributor. Product returned without a Service Form may not be warranty replaced or repaired.

Signet products with limited shelf-life (e.g. pH, ORP, chlorine electrodes, calibration solutions; e.g. pH buffers, turbidity standards or other solutions) are warranted out of box but not warranted against any damage, due to process or application failures (e.g. high temperature, chemical poisoning, dry-out) or mishandling (e.g. broken glass, damaged membrane, freezing and/or extreme temperatures).

### Product Registration

Thank you for purchasing the Signet line of Georg Fischer measurement products.

If you would like to register your product(s), you can now register online in one of the following ways:



- Visit our website [www.gfsignet.com](http://www.gfsignet.com) and click on **Product Registration Form**
- If this is a pdf manual (digital copy), [click here](#)
- Scan the QR Code on the left

### Safety Information

1. Depressurize and vent system prior to installation or removal.
2. Confirm chemical compatibility before use.
3. DO NOT exceed maximum temperature or pressure specs.
4. ALWAYS wear safety goggles or faceshield during installation and/or service.
5. DO NOT alter product construction.

	<b>Warning / Caution / Danger</b> Indicates a potential hazard. Failure to follow all warnings may lead to equipment damage, injury, or death
	<b>Personal Protective Equipment (PPE)</b> Always utilize the most appropriate PPE during installation and service of Signet products.
	<b>Pressurized System Warning</b> Sensor may be under pressure, take caution to vent system prior to installation or removal. Failure to do so may result in equipment damage and/or serious injury.
	<b>Hand Tighten Only</b> Overtightening may permanently damage product threads and lead to failure of the retaining nut.
	<b>Do Not Use Tools</b> Use of tool(s) may damage product beyond repair and potentially void product warranty.
	<b>Note / Technical Notes</b> Highlights additional information or detailed procedure.

### Chemical Compatibility

Georg Fischer Signet products are manufactured in a variety of wetted materials to suit various liquids and chemicals.

All plastic materials including typical piping types (PVC, PVDF, PP and PE) are more or less permeable to contained media, such as water or volatile substances, including some acids. This effect is not related to porosity, but purely a matter of gas diffusion through the plastic.

If the plastic material is compatible with the medium according to the application guidelines, the permeation will not damage the plastic itself. However, if the plastic encloses other sensitive components, as is the case with GF Signet plastic paddlewheel sensors, these may be affected or damaged by the media diffusing through the plastic body and rotor.

Failures of PVDF paddlewheel sensors when used in hot nitric acid applications have been reported. PVDF is known to allow for substantial permeation of nitric acid constituents without being damaged itself. No clear guideline can be given here, since the damaging effect to the sensor is highly dependent on temperature, pressure and concentration.

Utilizing sensors in applications with aggressive substances is possible. On special request GF Signet can provide sensors with a different internal resin encapsulation (potting) that will delay the damaging effect of acids to the sensors.

For all Special Product inquiries or to place an order, please email [signet-specialproduct@georgfischer.com](mailto:signet-specialproduct@georgfischer.com).



**WARNING!**

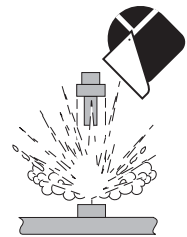

#### Paddlewheel Retaining Nuts: Red (515) and Blue (2536)

The retaining nuts of paddlewheel sensors are not designed for prolonged contact with aggressive substances. Strong acids, caustic substances and solvents or their vapor may lead to failure of the retaining nut, ejection of the sensor and loss of the process fluid with possibly serious consequences, such as damage to equipment and serious personal injury. Retaining nuts that may have been in contact with such substances, e.g. due to leakage or spilling, must be replaced.

## Table of Contents

Description.....	1
Warranty Statement.....	2
Product Registration.....	2
Safety Information.....	2
Chemical Compatibility.....	2
Table of Contents.....	3
Dimensions.....	3
Specifications.....	4
Location of Fitting.....	5
Sensor Mounting Position.....	5
Standard Sensor Installation.....	5
Sensor Wiring.....	5
Rotor Replacement Procedure.....	5
K-Factors.....	6
H-Dimensions.....	6
Signet Fittings.....	7
Ordering Information (515/8510).....	7
Ordering Information (2536/8512).....	8

## Dimensions

### 515/2536 Sensor

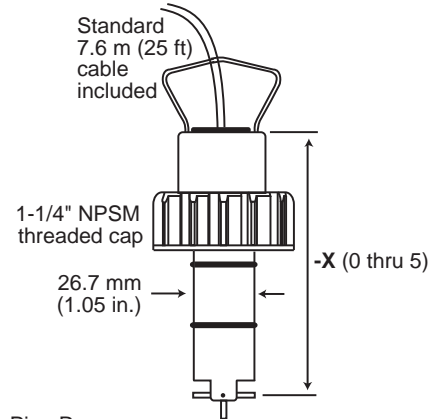

Pipe Range:

1/2 in. to 4 in.	-X0 = 104 mm (4.1 in.)	} Wet-tap Lengths
5 in. to 8 in.	-X1 = 137 mm (5.4 in.)	
10 in. and up	-X2 = 213 mm (8.4 in.)	
1/2 in. to 4 in.	-X3 = 297 mm (11.7 in.)	
5 in. to 8 in.	-X4 = 332 mm (13.1 in.)	
10 in. and up	-X5 = 408 mm (16.1 in.)	

### 8510-XX/8512-XX Integral Sensor shown with Transmitter and Integral Adapter Kit (sold separately)

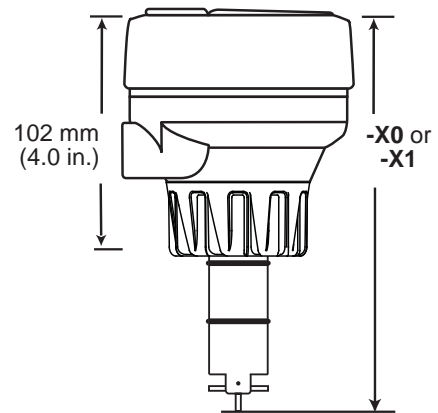

-X0 = 152 mm (6.0 in.)
-X1 = 185 mm (7.3 in.)

## Specifications

### General

#### Flow Rate Range:

515 .....	0.3 to 6 m/s (1 to 20 ft/s)
2536 .....	0.1 to 6 m/s (0.3 to 20 ft/s)

#### Pipe Size Range..... DN15 to DN900 (½ in. to 36 in.)

Cable Length .....	7.6 m (25 ft) standard
515 .....	60 m (200 ft) maximum
2536 .....	305 m (1000 ft) maximum

#### Cable type .....

2-conductor twisted pair w/ shield (22 AWG)

#### Minimum Reynolds Number.. 4500

### Materials:

Cap Material .....	Glass Filled Polypropylene
515:	Red
2536:	Blue

### Wetted Materials:

Sensor Body .....	Glass Filled Polypropylene (black) or PVDF
O-Rings .....	FPM (Std), EPR (EPDM) or FFFPM optional
Pin .....	Titanium, Hastelloy-C or PVDF; optional Ceramic, Tantalum, or Stainless Steel
Rotor .....	Black PVDF or Natural PVDF; optional ETFE with or without carbon fiber reinforced PTFE sleeve for rotor pin

### Shipping Weight:

-X0 .....	0.454 kg (1 lb)
-X1 .....	0.476 kg (1.04 lbs)
-X2 .....	0.680 kg (1.50 lbs)
-X3 .....	0.794 kg (1.75 lbs)
-X4 .....	0.850 kg (1.87 lbs)
-X5 .....	1.0 kg (2.20 lbs)
3519 .....	1.3 kg (2.86 lbs)

### Performance

Linearity .....	±1% of maximum range @ 25 °C (77 °F)
Repeatability .....	±0.5% maximum range @ 25 °C (77 °F)

### Electrical

#### 515 Sensor

Frequency .....	19.7 Hz per m/s nominal (6 Hz per ft/s)
Amplitude .....	3.3 V p/p per m/s nominal (1V p/p per ft/s)
Source Impedance .....	8 kΩ

#### 2536 Sensor

Frequency .....	49 Hz per m/s nominal (15 Hz per ft/s nominal)
Supply Voltage .....	5 to 24 VDC ±10% regulated
Supply Current .....	<1.5 mA @ 3.3 to 6 VDC <20 mA @ 6 to 24 VDC
Output Type .....	Open collector, sinking
Output Current .....	10 mA maximum

### Environmental Requirements

#### Pressure/Temperature Ratings

##### Standard and Integral Sensors:

<b>Polypropylene Body</b> .....	12.5 bar (180 psi) max. @ 20 °C (68 °F)
515 .....	1.7 bar (25 psi) max. @ 90 °C (194 °F)
2536 .....	1.7 bar (25 psi) max. @ 85 °C (185 °F)
Operating Temperature .....	-18 °C to 66 °C (0 °F to 150 °F)
<b>PVDF Body</b> .....	14 bar (200 psi) max. @ 20 °C (68 °F)
515 .....	1.7 bar (25 psi) max. @ 100 °C (212 °F)
2536 .....	1.7 bar (25 psi) max. @ 85 °C (185 °F)
Operating Temperature .....	-18 °C to 100 °C (0 °F to 212 °F)

##### Wet-Tap Sensor:

<b>Polypropylene Body</b> .....	7 bar @ 20 °C, 1.4 bar @ 66 °C (100 psi @ 68 °F, 20 psi @ 150 °F)
Max Removal Rating .....	1.7 bar @ 22 °C (25 psi @ 72 °F)
Operating Temperature .....	-18 °C to 66 °C (0 °F to 150 °F)

### Standards and Approvals

- CE (2536 Only)
- Manufactured under ISO 9001 for Quality, ISO 14001 for Environmental Management and OHSAS 18001 for Occupational Health and Safety.
- RoHS Compliant

 China RoHS (Go to [www.gfsignet.com](http://www.gfsignet.com) for details)

### FC Declaration of Conformity according to FCC Part 15

This device complies with Part 15 of the FCC rules. Operation is subject to the following two conditions:  
 (1) This device may not cause harmful interference, and  
 (2) This device must accept any interference received, including interference that may cause undesired operation.

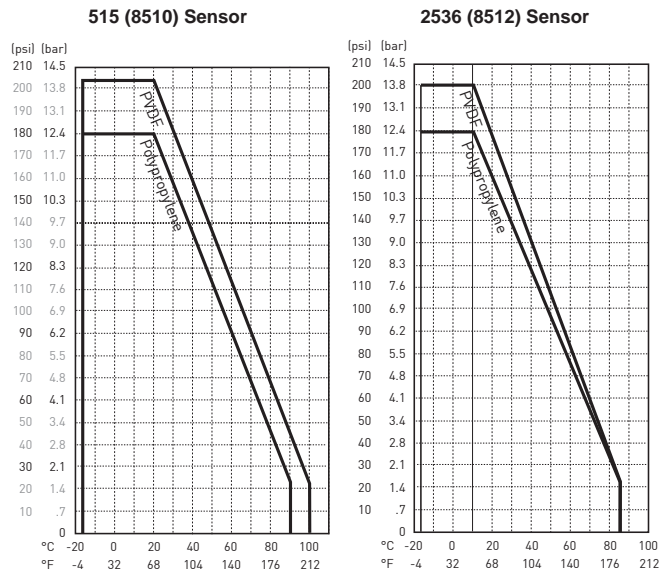

### Location of Fitting

Recommended sensor upstream/downstream mounting requirements.

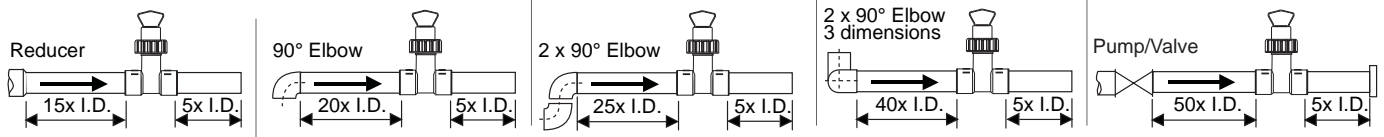

### Sensor Mounting Position

#### Horizontal pipe runs:

- Mount sensor in the upright (0°) position for best performance (pipe must be full).
- Mount at a maximum of 45° when air bubbles are present.
- Do not mount on the bottom of the pipe when sediments are present.

#### Vertical pipe runs:

- Mount sensor in any orientation.
- Upward flow is preferred to ensure full pipe.

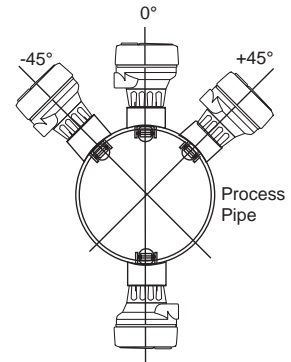

### Standard Sensor Installation

- Lubricate O-rings with a non-petroleum based, viscous lubricant (grease) compatible with the system.
- Using an alternating/twisting motion, lower the sensor into the fitting, making sure the installation arrows on the black cap are pointing in the direction of flow, see Figure A.
- Engage one thread of the sensor cap then turn the sensor until the alignment tab is seated in the fitting notch.

**Hand tighten the sensor cap. DO NOT use any tools on the sensor cap or the cap threads and/or fitting flange threads will be damaged, see Figure B.**

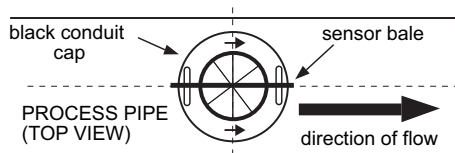

Figure A

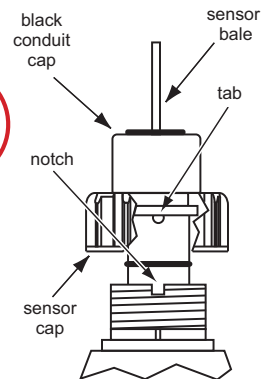

Figure B

### Sensor Wiring

#### Technical Notes



- Use 2-conductor shielded cable for cable extensions.
- Cable shield must be maintained through cable splice.
- Refer to your instrument manual for specific wiring details.

#### 2536 Sensor Connections to Other Brand Instruments

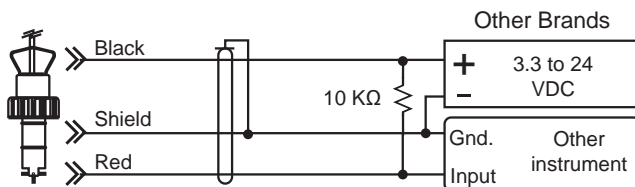

- DC sensor power supplied from Signet instrument.
- 10 KΩ Pull-up resistor may be required for non-Signet brand instrument.

#### 515 Sensor Connections to Signet Instruments

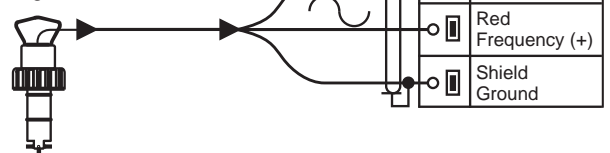

#### 2536 Sensor Connections to Signet Instruments

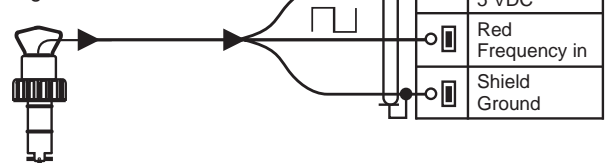

### Rotor Replacement Procedure

- To remove the rotor, insert a small screwdriver between the rotor and the ear of the sensor.
- Twist the screwdriver blade to flex the ear outward enough to remove one end of the rotor and pin.
- **DO NOT** flex the ear any more than necessary! If it breaks, the sensor cannot be repaired.
- Install the new rotor by inserting one tip of the pin into the hole, then flex the opposite ear back enough to slip rotor into place.

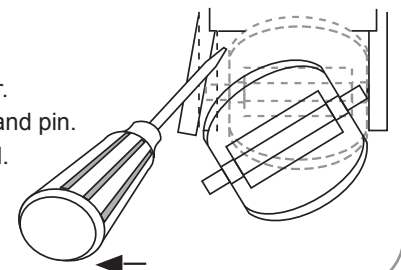



### K-Factors

A **K-Factor** is the number of pulses a sensor will generate for each engineering unit of fluid that passes the sensor. K-factors for water are listed below in U.S. gallons and liters. For example, in a 1-inch PVC pipe, the 515 paddlewheel generates 172.07 pulses per gallon of water passing the rotor. K-factors are listed for pipes up to 12 inches. For pipes over 12 inches, consult your Signet distributor.

PIPE SIZE (IN.)	FITTING	515/8510-XX		2536/8512-XX	
		LITERS	U.S. GAL	LITERS	U.S. GAL
<b>SCH 80 PVC TEES FOR SCH 80 PVC PIPE</b>					
1/2	MPV8T005	137.42	520.12	271.37	1027.1
3/4	MPV8T007	78.61	297.52	154.08	583.19
1	MPV8T010	45.46	172.07	88.65	335.53
1-1/4	MPV8T012	24.19	91.54	47.24	178.79
1-1/2	MPV8T015	16.44	62.22	32.08	121.42
2	MPV8T020	9.60	36.32	18.87	71.44
<b>SCH 80 PVC TEES FOR SCH 80 CPVC PIPE</b>					
2-1/2	PV8T025	5.7683	21.833	11.359	42.994
3	PV8T030	3.5775	13.541	7.0414	26.652
4	PV8T040	2.0147	7.6258	3.9645	15.006
<b>SCH 80 CPVC TEES FOR SCH 80 CPVC PIPE</b>					
1/2	MCPV8T005	137.42	520.12	271.37	1027.1
3/4	MCPV8T007	78.61	297.52	154.08	583.19
1	MCPV8T010	45.46	172.07	88.65	335.53
1-1/4	MCPV8T012	24.19	91.54	47.24	178.79
1-1/2	MCPV8T015	16.44	62.22	32.08	121.42
2	MCPV8T020	9.60	36.32	18.87	71.44
<b>SCH 80 PVC SADDLES FOR SCH 80 PVC PIPE</b>					
2	PV8S020	8.5812	32.480	17.633	66.739
2-1/2	PV8S025	5.7683	21.833	11.359	42.994
3	PV8S030	3.5775	13.541	7.0414	26.652
4	PV8S040	2.0147	7.6258	3.9645	15.006
6	PV8S060	1.0997	4.1623	2.1994	8.3246
8	PV8S080	0.6263	2.3705	1.3253	5.0164
10	PV8S100	0.4042	1.5300	0.808	3.0600
12	PV8S120	0.2801	1.0600	0.571	2.1600
<b>SCH 80 PVC SADDLE ON SCH 40 PVC PIPE</b>					
2	PV8S020	7.2259	27.350	14.452	54.700
2-1/2	PV8S025	4.9866	18.874	9.8175	37.159
3	PV8S030	3.3389	12.638	6.2608	23.697
4	PV8S040	1.7776	6.7282	3.5552	13.456
6	PV8S060	0.9854	3.7297	1.9708	7.4594
8	PV8S080	0.5688	2.1527	1.1966	4.5292
10	PV8S100	0.3567	1.3500	0.740	2.8000
12	PV8S120	0.2536	0.9600	0.523	1.9800

PIPE SIZE (IN.)	FITTING	515/8510-XX		2536/8512-XX	
		LITERS	U.S. GAL	LITERS	U.S. GAL
<b>CARBON STEEL TEES ON SCH 40 PIPE</b>					
1/2	CS4T005	97.808	370.20	199.74	756.00
3/4	CS4T007	56.027	212.06	115.90	438.69
1	CS4T010	37.289	141.14	75.768	286.78
1-1/4	CS4T012	16.025	60.655	32.026	121.22
1-1/2	CS4T015	11.982	45.350	24.079	91.139
2	CS4T020	7.0717	26.767	14.391	54.468
<b>STAINLESS STEEL TEES ON SCH 40 PIPE</b>					
1/2	CR4T005	94.838	358.96	193.98	734.20
3/4	CR4T007	53.530	202.61	108.88	412.10
1	CR4T010	33.590	127.14	66.764	252.70
1-1/4	CR4T012	16.357	61.910	33.849	128.12
1-1/2	CR4T015	10.676	40.410	20.428	77.320
2	CR4T020	5.8917	22.300	12.095	45.780
<b>GALVANIZED IRON TEES ON SCH 40 PIPE</b>					
1	IR4T010	27.619	104.54	56.277	213.01
1-1/4	IR4T012	16.639	62.979	33.751	127.75
1-1/2	IR4T015	12.335	46.688	24.941	94.401
2	IR4T020	7.7832	29.459	15.699	59.420
<b>BRONZE TEES ON SCH 40 PIPE</b>					
1	BR4T010	27.619	104.54	56.277	213.01
1-1/4	BR4T012	16.639	62.979	33.751	127.75
1-1/2	BR4T015	12.335	46.688	24.941	94.401
2	BR4T020	7.7832	29.459	15.699	59.420
<b>COPPER TEE FITTINGS ON COPPER PIPE SCH K</b>					
1/2	CUKT005	117.10	443.21	242.50	917.84
3/4	CUKT007	56.052	212.16	113.15	428.27
1	CUKT010	33.600	127.18	67.749	256.43
1-1/4	CUKT012	23.307	88.218	46.615	176.44
1-1/2	CUKT015	15.049	56.962	30.565	115.69
2	CUKT020	7.7595	29.370	16.746	63.385
<b>COPPER TEE FITTINGS ON COPPER PIPE SCH L</b>					
1/2	CUKT005	109.49	414.41	226.74	858.22
3/4	CUKT007	50.485	191.09	101.91	385.74
1	CUKT010	31.662	119.84	63.841	241.64
1-1/4	CUKT012	22.576	85.451	45.152	170.90
1-1/2	CUKT015	14.573	55.160	29.598	112.03
2	CUKT020	7.5575	28.605	16.310	61.74

PIPE SIZE (IN.)	FITTING	515/8510-XX		2536/8512-XX	
		LITERS	U.S. GAL	LITERS	U.S. GAL
<b>STAINLESS STEEL WELDOLETS ON SCH 40 PIPE</b>					
2-1/2	CR4W025	4.9670	18.800	9.9339	37.600
3	CR4W030	3.2153	12.170	6.4306	24.340
4	CR4W040	1.8388	6.9600	3.6777	13.920
5	CR4W050	1.3897	5.2600	2.8692	10.860
6	CR4W060	0.9749	3.6900	1.9868	7.5200
8	CR4W080	0.5627	2.1300	1.1466	4.3400
10	CR4W100	0.3567	1.3500	0.7292	2.7600
12	CR4W120	0.2536	0.9600	0.5125	1.9400
<b>CARBON STEEL WELDOLETS ON SCH 40 PIPE</b>					
2-1/2	CS4W025	4.9670	18.800	9.9339	37.600
3	CS4W030	3.2153	12.170	6.4306	24.340
4	CS4W040	1.8388	6.9600	3.6777	13.920
5	CS4W050	1.3897	5.2600	2.8692	10.860
6	CS4W060	0.9749	3.6900	1.9868	7.5200
8	CS4W080	0.5627	2.1300	1.1466	4.3400
10	CS4W100	0.3567	1.3500	0.7292	2.7600
12	CS4W120	0.2536	0.9600	0.5125	1.9400
<b>COPPER/BRONZE BRAZOLETS ON SCH 40 PIPE</b>					
2-1/2	BR4B025	4.9670	18.800	9.934	37.600
3	BR4B030	3.2153	12.170	6.431	24.340
4	BR4B040	1.8388	6.9600	3.678	13.920
5	BR4B050	1.3897	5.2600	2.869	10.860
6	BR4B060	0.9749	3.6900	1.987	7.5200
8	BR4B080	0.5627	2.1300	1.147	4.3400
10	BR4B100	0.3567	1.3500	0.729	2.7600
12	BR4B120	0.2536	0.9600	0.513	1.9400
<b>SCH 80 IRON SADDLES ON SCH 80 PIPE</b>					
2	IR8S020	8.5495	32.360	17.099	64.720
2-1/2	IR8S025	5.8705	22.220	11.223	42.480
3	IR8S030	3.5456	13.420	6.980	26.420
4	IR8S040	2.0238	7.6600	3.884	14.700
5	IR8S050	1.5482	5.8600	3.218	12.180
6	IR8S060	1.0806	4.0900	2.230	8.4400
8	IR8S080	0.6156	2.3300	1.295	4.9000
10	IR8S100	0.4042	1.5300	0.808	3.0600
12	IR8S120	0.2801	1.0600	0.571	2.1600
<b>SCH 80 IRON SADDLE ON SCH 40 PIPE</b>					
2	IR8S020	7.0859	26.820	14.172	53.640
2-1/2	IR8S025	4.9670	18.800	9.934	37.600
3	IR8S030	3.1678	11.990	6.135	23.220
4	IR8S040	1.8098	6.8500	3.503	13.260
5	IR8S050	1.4082	5.3300	2.917	11.040
6	IR8S060	0.9934	3.7600	1.913	7.2400
8	IR8S080	0.5627	2.1300	1.162	4.4000
10	IR8S100	0.3567	1.3500	0.740	2.8000
12	IR8S120	0.2536	0.9600	0.523	1.9800

### H-Dimensions

The plastic sensor insert in the Weldolet fitting **MUST** be removed during the welding process. When reinstalled, it is important that the insert be threaded to the proper height ("H" dimension).

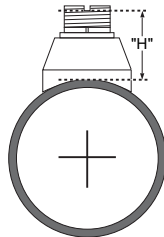









Weldolet part number	"H" dimension mm	"H" dimension inches	Weldolet part number	"H" dimension mm	"H" dimension inches
CS4W020	60.45	2.38	CS4W240	105.66	4.16
CS4W025	62.99	2.48	CS4W360	104.14	4.10
CS4W030	62.73	2.47			
CS4W040	62.23	2.45	CR4W020	60.45	2.38
CS4W050	82.29	3.24	CR4W025	62.99	2.48
CS4W060	78.99	3.11	CR4W030	62.73	2.47
CS4W080	73.15	2.88	CR4W040	62.23	2.45
CS4W100	143.00	5.63	CR4W050	82.29	3.24
CS4W120	137.16	5.25	CR4W060	78.99	3.11
CS4W140	129.54	5.40	CS4W080	73.15	2.88
CS4W160	123.19	4.85	CR4W100	143.00	5.63
CS4W180	116.84	4.60	CR4W120	137.16	5.40
CS4W200	111.25	4.38			

### K-Factors DIN Pipes

PIPE SIZE	FITTING	515/8510-XX		2536/8512-XX	
		LITERS	U.S. GAL	LITERS	U.S. GAL
<b>POLYPROPYLENE FITTINGS (DIN/ISO AND BS AND ANSI)</b>					
DN 15	PPMT005	127.23	481.55	251.75	952.87
DN 20	PPMT007	73.207	277.09	148.77	563.10
DN 25	PPMT010	37.300	141.18	77.042	291.60
DN 32	PPMT012	22.071	83.540	44.709	169.22
DN 40	PPMT015	13.544	51.265	27.450	103.90
DN 50	PPMT020	7.8193	29.596	16.060	60.789
<b>PVDF FITTINGS (DIN/ISO AND BS AND ANSI)</b>					
DN 15	SFMT005	111.19	420.87	218.56	827.26
DN 20	SFMT007	60.277	228.15	129.42	489.87
DN 25	SFMT010	36.116	136.70	74.915	283.55
DN 32	SFMT012	20.950	79.294	41.899	158.59
DN 40	SFMT015	11.490	43.490	22.980	86.980
DN 50	SFMT020	6.8450	25.908	13.312	50.385
<b>PVC FITTINGS (DIN/ISO) - EUROPE ONLY</b>					
DN 15	PVMT005	128.45	486.18	256.90	972.37
DN 20	PVMT007	64.160	242.85	128.32	485.69
DN 25	PVMT010	39.270	148.64	78.540	297.274
DN 32	PVMT012	22.490	85.125	44.980	170.249
DN 40	PVMT015	13.700	51.855	27.400	103.709
DN 50	PVMT020	7.8600	29.750	15.720	59.500

## Signet Fittings

Type	Description	Type	Description
Plastic tees 	<ul style="list-style-type: none"> <li>• 0.5 to 2 inch versions</li> <li>• MPVC or CPVC</li> </ul>	Iron, Carbon Steel, 316 SS Threaded tees 	<ul style="list-style-type: none"> <li>• 0.5 to 2 in. versions</li> <li>• Mounts on threaded pipe ends</li> </ul>
PVC Glue-on Saddles 	<ul style="list-style-type: none"> <li>• Available in 10 and 12 inch sizes only</li> <li>• Cut 2-1/2 inch hole in pipe</li> <li>• Weld in place using solvent cement</li> </ul>	Carbon steel & stainless steel Weld-on Weldolets 	<ul style="list-style-type: none"> <li>• 2 to 4 inch, cut 1-7/16 inch hole</li> <li>• Over 4 inch, cut 2-1/8 inch hole in pipe</li> </ul>
PVC Clamp-on Saddles 	<ul style="list-style-type: none"> <li>• 2 to 4 inch, cut 1-7/16 inch hole in pipe</li> <li>• 6 to 8 inch, cut 2-1/8 inch hole in pipe</li> </ul>	Fiberglass tees FPT 	<ul style="list-style-type: none"> <li>• 1.5 in. to 2 in. PVDF insert</li> </ul>
Iron Strap-on saddles 	<ul style="list-style-type: none"> <li>• 2 to 4 inch, cut 1-7/16 inch hole in pipe</li> <li>• Over 4 inch, cut 2-1/8 inch hole in pipe</li> <li>• Special order 14 in. to 36 in.</li> </ul>	Metric Union Fitting 	<ul style="list-style-type: none"> <li>• For pipes from DN 15 to 50 mm</li> <li>• PP or PVDF</li> </ul>

## Ordering Information

### 515/8510-XX

Mfr. Part No.	Code	Description
P51530-H0	198 801 659	Sensor, Polypropylene, Hastelloy-C, Black PVDF; 0.5 to 4 inch
P51530-P0	198 801 620	Sensor, Polypropylene, Titanium Rotor Pin, PVDF Rotor (black), 0.5 to 4 inch
P51530-P1	198 801 621	Sensor, Polypropylene, Titanium Rotor Pin, PVDF Rotor (black) 5 to 8 inch
P51530-P2	198 801 622	Sensor, Polypropylene, Titanium Rotor Pin, PVDF Rotor (black) 10 to 36 inch
P51530-P3	198 840 310	Sensor, Wet-Tap, Polypropylene, Titanium Rotor Pin, PVDF Rotor (black), 0.5 to 4 inch
P51530-P4	198 840 311	Sensor, Wet-Tap, Polypropylene, Titanium Rotor Pin, PVDF Rotor (black) 5 to 8 inch
P51530-P5	198 840 312	Sensor, Wet-Tap, Polypropylene, Titanium Rotor Pin, PVDF Rotor (black) 10 to 36 inch
P51530-S0	198 801 661	Sensor, polypropylene, PVDF (natural), Black PVDF; 0.5 to 4 inch
P51530-T0	198 801 663	Sensor, PVDF (natural), PVDF (nat.) Rotor Pin, PVDF Rotor (nat.), 0.5 to 4 inch
P51530-T1	198 801 664	Sensor, PVDF (natural), PVDF (nat.) Rotor Pin, PVDF Rotor (nat.), 5 to 8 inch
P51530-V0	198 801 623	Sensor, PVDF (natural), Hastelloy-C Rotor Pin, PVDF Rotor (natural), 0.5 to 4 inch
P51530-V1	198 801 624	Sensor, PVDF (natural), Hastelloy-C Rotor Pin, PVDF Rotor (natural), 5 to 8 inch
P51530-V2	198 801 625	Sensor, PVDF (natural), Hastelloy-C Rotor Pin, PVDF Rotor (natural), 10 to 36 inch
3-8510-P0	198 864 504	Sensor, Integral, PP, Titanium Rotor Pin, PVDF Rotor (black), 0.5 to 4 inch
3-8510-P1	198 864 505	Sensor, Integral, PP, Titanium Rotor Pin, PVDF Rotor (black) 5 to 8 inch
3-8510-T0	159 000 622	Sensor, Integral, PVDF (nat.), PVDF (nat.) Rotor Pin, PVDF Rotor (nat.), 0.5 to 4 inch
3-8510-V0	198 864 506	Sensor, Integral, PVDF (nat.), Hastelloy-C Rotor Pin, PVDF Rotor (nat.), 0.5 to 4 inch
3-3519/515-P3	159 000 819	Sensor & Wet-Tap Assy., PP, Titanium Rotor Pin, PVDF Rotor (black), 0.5 to 4 inch
3-3519/515-P4	159 000 820	Sensor & Wet-Tap Assy., PP, Titanium Rotor Pin, PVDF Rotor (black), 5 to 8 inch
3-3519/515-P5	159 000 821	Sensor & Wet-Tap Assy., PP, Titanium Rotor Pin, PVDF Rotor (black), 10 to 36 inch

### Replacement Parts 515/8510

M1538-2	198 801 181	Rotor, PVDF Black
P51547-3	159 000 474	Rotor, PVDF Natural
M1538-4	198 820 018	Rotor, ETFE
P51550-3	198 820 043	Rotor and Pin, PVDF Natural
3-0515.322-1	198 820 059	Sleeved Rotor, PVDF Black
3-0515.322-2	198 820 060	Sleeved Rotor, PVDF Natural
3-0515.322-3	198 820 017	Sleeved Rotor, ETFE
P31542	198 801 630	Sensor Cap, Red (for use with 515)

## Ordering Information

**2536/8512-XX**

Mfr. Part No.	Code	Description
3-2536-P0	198 840 143	Sensor, Polypropylene, Titanium Rotor Pin, PVDF Rotor (black), ½ to 4 inch
3-2536-P1	198 840 144	Sensor, Polypropylene, Titanium Rotor Pin, PVDF Rotor (black) 5 to 8 inch
3-2536-P2	198 840 145	Sensor, Polypropylene, Titanium Rotor Pin, PVDF Rotor (black) 10 to 36 inch
3-2536-P3	159 000 758	Sensor, Wet-Tap, Polypropylene, Titanium Rotor Pin, PVDF Rotor (black), ½ to 4 inch
3-2536-P4	159 000 759	Sensor, Wet-Tap, Polypropylene, Titanium Rotor Pin, PVDF Rotor (black) 5 to 8 inch
3-2536-P5	159 000 760	Sensor, Wet-Tap, Polypropylene, Titanium Rotor Pin, PVDF Rotor (black) 10 to 36 inch
3-2536-V0	198 840 146	Sensor, PVDF (natural), Hastelloy-C Rotor Pin, PVDF Rotor (natural), ½ to 4 inch
3-2536-V1	198 840 147	Sensor, PVDF (natural), Hastelloy-C Rotor Pin, PVDF Rotor (natural), 5 to 8 inch
3-2536-T0	198 840 149	Sensor, PVDF (natural), PVDF (nat.) Rotor Pin, PVDF Rotor (natural), ½ to 4 inch
3-8512-P0	198 864 513	Sensor, Integral, PP, Titanium Rotor Pin, PVDF Rotor (black), ½ to 4 inch
3-8512-P1	198 864 514	Sensor, Integral, PP, Titanium Rotor Pin, PVDF Rotor (black) 5 to 8 inch
3-8512-T0	198 864 518	Sensor, Integral, PVDF (nat.), PVDF (nat.) Rotor Pin, PVDF Rotor (nat.), ½ to 4 inch
3-8512-V0	198 864 516	Sensor, Integral, PVDF (nat.), Hastelloy-C Rotor Pin, PVDF Rotor (nat.), ½ to 4 inch
3-3519/2536-P3	159 000 822	Sensor & Wet-Tap Assy., PP, Titanium Rotor Pin, PVDF Rotor (black), ½ to 4 inch
3-3519/2536-P4	159 000 823	Sensor & Wet-Tap Assy., PP, Titanium Rotor Pin, PVDF Rotor (black), 5 to 8 inch
3-3519/2536-P5	159 000 824	Sensor & Wet-Tap Assy., PP, Titanium Rotor Pin, PVDF Rotor (black), 10 to 36 inch

**Replacement Parts 2536/8512**

3-2536.320-1	198 820 052	Rotor, PVDF Black
3-2536.320-2	159 000 272	Rotor, PVDF Natural
3-2536.320-3	159 000 273	Rotor, ETFE
3-2536.321	198 820 054	Rotor and Pin, PVDF Natural
3-2536.322-1	198 820 056	Sleeved Rotor, PVDF Black
3-2536.322-2	198 820 057	Sleeved Rotor, PVDF Natural
3-2536.322-3	198 820 058	Sleeved Rotor, ETFE
P31542-3	159 000 464	Sensor Cap, Blue (for use with 2536)

**Accessories 515/8510 & 2536/8512**

M1546-1	198 801 182	Rotor Pin, Titanium
M1546-2	198 801 183	Rotor Pin, Hastelloy-C
M1546-3	198 820 014	Rotor Pin, Tantalum
M1546-4	198 820 015	Rotor Pin, Stainless Steel
P51545	198 820 016	Rotor Pin, Ceramic
1220-0021	198 801 186	O-Ring, FPM
1224-0021	198 820 006	O-Ring, EPDM
1228-0021	198 820 007	O-Ring, FFKM
P31536	198 840 201	Sensor Plug, Polypropylene
P31934	159 000 466	Conduit Cap
P51589	159 000 476	Conduit Adapter Kit
5523-0222	159 000 392	Cable (per foot), 2 conductor with shield, 22 AWG
3-8050	159 000 184	Universal mount kit
3-8050-1	159 000 753	Universal junction box
3-8050.390-1	159 001 702	Retaining Nut Replacement Kit, NPT, Valox®
3-8050.390-3	159 310 116	Retaining Nut Replacement Kit, NPT, PP
3-8050.390-4	159 310 117	Retaining Nut Replacement Kit, NPT, PVDF
3-8051	159 000 187	Transmitter integral adapter (for 8510 and 8512)



Georg Fischer Signet LLC, 3401 Aero Jet Avenue, El Monte, CA 91731-2882 U.S.A. • Tel. (626) 571-2770 • Fax (626) 573-2057  
 For Worldwide Sales and Service, visit our website: [www.gfsignet.com](http://www.gfsignet.com) • Or call (in the U.S.): (800) 854-4090  
 For the most up-to-date information, please refer to our website at [www.gfsignet.com](http://www.gfsignet.com)