

Signet 525 Metalex Flow Sensor



P52590-1 Rev. R 10/14

Operating Instructions

P525-1, P525-1S



P525-2, P525-2S



P52509 & P52509-2 Rotor Kits

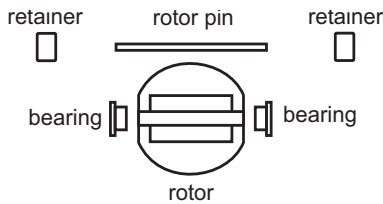

- [English](#)
- [Deutsch](#)
- [Français](#)
- [Español](#)



Dimensions

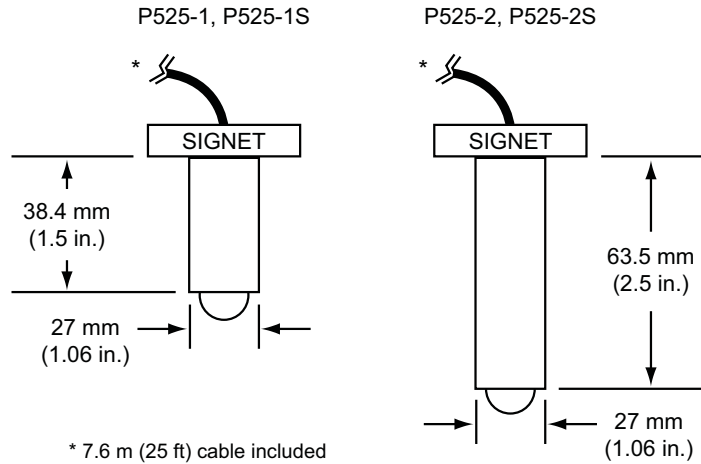

Specifications

General

Operation Range0.5 m/s to 6 m/s (1.6 ft/s to 20 ft/s) (depending on pipe size)
 Pipe Size Range.....DN15 to DN300 (½ in. to 12 in.)
 Linearity±1% of max. range @ 25 °C (77 °F)
 Repeatability.....±0.5% of max. range @ 25 °C (77 °F)

Wetted Materials

Sensor Body316 SS (ACI type CF-8M per ASTM A351), DIN 17440
 Rotor Material.....CB7Cu-1 Alloy
 Rotor Pin.....Tungsten Carbide GRP 1 or 316 SS
 Retainers (2).....316 stainless steel (1.4401)
 Rotor Bearings (2).....Carbon fiber reinforced PTFE
 GasketKLINGER®sil C-4401 (supplied with fitting)

Electrical

Frequency.....39 Hz per m/s (12 Hz per ft/s) nominal
 Amplitude.....5 to 8 mV p-p per Hz
 Source Impedance11.6 KΩ
 Coil Inductance.....3.5 Henrys @ 25 °C
 Cable Length7.6 m (25 ft), can be extended up to 61 m (200 ft)
 Cable Type22 AWG, 2-conductor w/shield

Maximum Temperature/Pressure Rating

Socket Weld or Weld-On
 Mini-Tap fittings.....103 bar @ 149 °C (1500 psi @ 300 °F)
 Operating Temperature.....-18 °C to 149 °C (0 °F to 300 °F)

Standards and Approvals

- Manufactured under ISO 9001 for Quality, ISO 14001 for Environmental Management and OHSAS 18001 for Occupational Health and Safety.
- RoHS compliant
- China RoHS (Go to www.gfsignet.com for details)

Warranty Information

Refer to your local Georg Fischer Sales office for the most current warranty statement.

All warranty and non-warranty repairs being returned must include a fully completed Service Form and goods must be returned to your local GF Sales office or distributor. Product returned without a Service Form may not be warranty replaced or repaired.

Signet products with limited shelf-life (e.g. pH, ORP, chlorine electrodes, calibration solutions; e.g. pH buffers, turbidity standards or other solutions) are warranted out of box but not warranted against any damage, due to process or application failures (e.g. high temperature, chemical poisoning, dry-out) or mishandling (e.g. broken glass, damaged membrane, freezing and/or extreme temperatures).

Product Registration





Thank you for purchasing the Signet line of Georg Fischer measurement products.

If you would like to register your product(s), you can now register online in one of the following ways:

- Visit our website www.gfsignet.com. Under **Service and Support** click on **Product Registration Form**
- If this is a pdf manual (digital copy), [click here](#)

Safety Information

1. Do not remove from pressurized lines.
2. Do not exceed maximum temperature and pressure specifications.
3. Pipe fitting must be installed by certified welder only.
4. Do not install/service without following installation instructions (see sensor manual).
5. Wear safety goggles and face shield during installation and service.
6. Do not alter product construction.
7. Failure to follow safety instructions could result in severe personal injury!

	Caution / Warning / Danger Indicates a potential hazard. Failure to follow all warnings may lead to equipment damage, injury, or death
	Personal Protective Equipment (PPE) Always utilize the most appropriate PPE during installation and service of Signet products.
	Pressurized System Warning Sensor may be under pressure, take caution to vent system prior to installation or removal. Failure to do so may result in equipment damage and/or serious injury.
	Note / Technical Notes Highlights additional information or detailed procedure.

Maintenance

The 525 sensor requires little or no maintenance of any kind, with the exception of an occasional sensor/paddlewheel cleaning.

Sensor Removal Procedure

1. Depressurize and drain pipe.
2. Remove the four sensor flange bolts and lock washers. Pull upward on the sensor flange with an alternating twisting motion.



WARNING!

Do not remove from pressurized lines. Wear safety goggles and faceshield during installation/service.

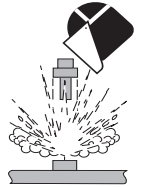

Location of Fitting

Recommended sensor upstream and downstream mounting requirements.

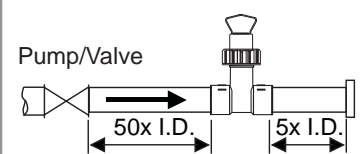
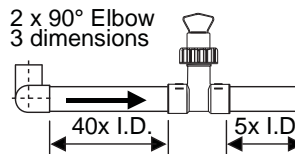
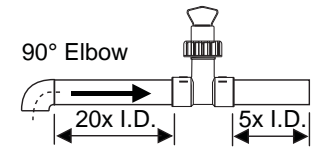
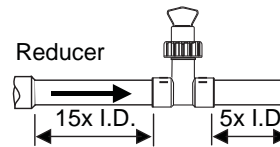
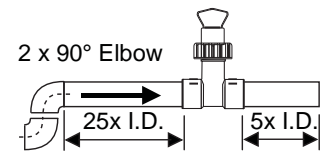

Sensor Mounting Position

- Horizontal pipe runs: Mount sensor in the upright (0°) position for best overall performance. Mount at a maximum of 45° when air bubbles are present. Do not mount on the bottom of pipe when sediments are present.
- Vertical pipe runs: Sensor must be mounted in lines with UPWARD flow only.

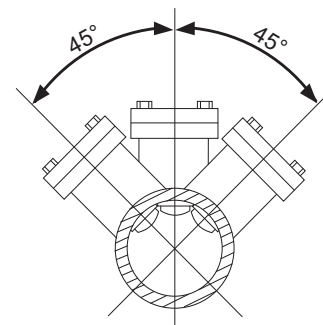

Sensor-Fitting Selection

The 525 is designed for installation into SCH 40 stainless steel pipes via the Signet Metalex Tee, Mini-Tap.



525-1 Sensor
(525-1S for stainless steel pin)

Wetted fitting materials:
316 SS



Tee Fitting,
hardware included

Signet Metalex Tee Fittings (Sensor PN P525-1/-1S)

Pipe (in.)	Fitting	Code
0.50	P526-2005	198 840 501
0.75	P526-2007	198 840 502
1.00	P526-2010	198 840 503



525-2 Sensor
(525-2S for stainless steel pin)

Wetted fitting materials:
316 SS
347 SS

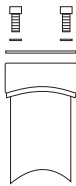

Mini-Tap Fitting,
hardware included

Signet Metalex Mini-Tap Fittings (Sensor PN P525-2/-2S)

Pipe (in.)	Fitting	Code
1.25	P526-2012	159 000 494
1.50	P526-2015	198 840 506
2.00	P526-2020	159 000 495
2.50	P526-2025	159 000 496
3.00	P526-2030	159 000 497
4.00	P526-2040	159 000 498
5.00	P526-2050	159 000 499
6.00	P526-2060	159 000 500
8.00	P526-2080	159 000 501
10.0	P526-2100	159 000 502
12.0	P526-2120	159 000 503

Required Hardware

Signet Metalex Tee & Mini-Tap Fittings, P526-2XXX

- 0.5 to 1 inch pipes: P526-2 series fitting required
- 1.25 to 12 inch pipes: P526-2 series fitting and 27 mm (1-1/16 in.) diameter drill required

NOTE: Mini-Tap fittings are welded onto the pipe and are used with Signet 525-1 and 525-2 sensors.



CAUTION

Welds **MUST** be made by a certified welder who is licensed to weld stainless steel and other high carbon grade steels.

Tee & Mini-Tap Fitting Installation

1. Select an appropriate mounting location as outlined in sections 1 and 2.
2. Depressurize and drain pipe.
3. Use the following welding and installation procedures appropriate for your fitting/pipe size:

Signet Tee Fittings, 0.5 in. to 1 in.

- Insert pipe into fitting socket
- Make sure the pipe is parallel to the bottom of the Mini-Tap fitting.
- Weld pipe into place.

Signet Mini-Tap Fittings, 1.25 in. to 12 in.

- Drill a 27 mm (1-1/16 in.) diameter hole completely through the ONE surface of the pipe. Thoroughly deburr inner and outer edges of hole.
- Tack weld the Mini-Tap fitting onto the pipe, making sure the hole in the pipe is lined up with the Mini-Tap fitting hole.
- Weld the Mini-Tap fitting onto the pipe.

Sensor Installation

1. Set the gasket supplied with the fitting onto the fitting flange, making sure the holes align.
2. Remove the red rotor protection cap and insert the sensor into the fitting, making sure not to bump the rotor assembly. Make sure the arrow on the side of the sensor is pointing in the direction of flow.
3. Slip two washers onto each bolt and insert the bolt/washer onto each of the four fitting flange holes.
4. Snug all four flange bolts in a criss-cross pattern. Using a torque wrench (when possible), torque the flange nuts in a crisscross pattern to 52 foot pounds.

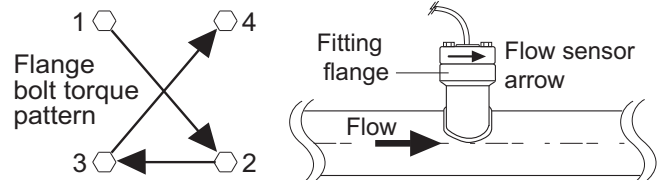

Sensor Wiring

- Use 2-conductor shielded cable for cable splices to 61 m (200 ft).
- Maintain cable shield through splice.
- Shield the unjacketed silver (ground) wire using electrical tape to prevent potential noise interference and/or shorting hazards.

9900 Terminal

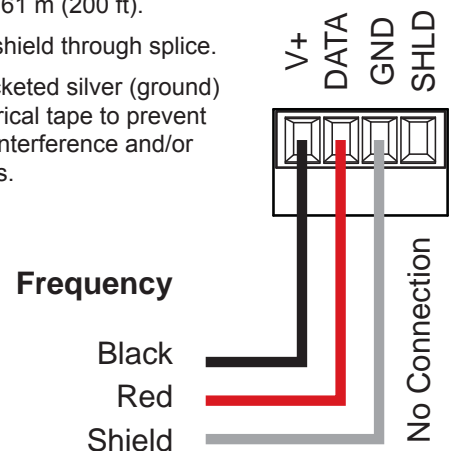

Rotor Replacement Procedure

1. With a small pair of needle-nose pliers, firmly grip the center of the rotor pin (axle) and with a twisting motion, bend the rotor pin into an "S" shape. This should pull the ends of the pin out of the retainers and free the rotor assembly.

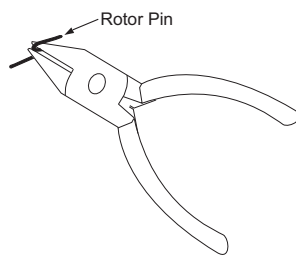

2. Remove rotor pin retainer from each side by gently tapping it inwards using a punch. Install a new retainer into the sensor body with its rotor pin clearance hole inward. Only install one retainer at this time.

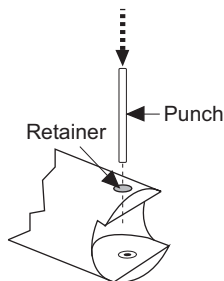

3. Insert the new rotor assembly and bearings into the rotor housing of the sensor and place the new rotor pin (axle) through the open end of the rotor housing, through the rotor and bearings, and into the previously installed retainer.

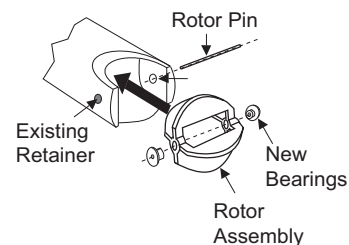

4. Using a vise or C-clamp, press the second retainer into the hole in the sensor body while lining up the rotor pin with the center of the retainer hole.

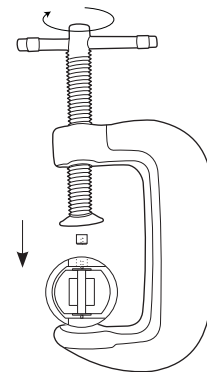

NOTE: A hammer and center punch can also be used if a clamp or vice is not available

K-Factors

The K-Factor is the number of pulses the sensor will generate for each engineering unit of fluid which passes.

They are listed in U.S. gallons and in liters. For example, in a 1 inch SCH 40S stainless steel pipe, the sensor generates 266.17 pulses per gallon of fluid passing the rotor. K-Factors are listed for SCH 40S stainless steel pipes up to 12 inch.

Conversion Formulas

1 U.S. gallon = 0.003785 cubic meters
0.000003069 Acre feet
8.3454 pounds of water

SCH 40S Stainless Steel Pipe per ANSI B36.19

Pipe Size (inch)	K-Factor Pulses/ U.S. GAL	K-Factor Pulses/ U.S. Liter	A-Factor GPM / Hz	A-Factor LPM / Hz
½	873.03	230.66	0.0687	0.2601
¾	515.41	136.17	0.1164	0.4406
1	266.17	70.322	0.2254	0.8532
1 ¼	148.84	39.324	0.4031	1.5258
1 ½	107.98	28.528	0.5557	2.1032
2	64.808	17.122	0.9258	3.5042
2 ½	44.685	11.806	1.3427	5.0822
3	28.579	7.5506	2.0994	7.9464
4	16.302	4.3070	3.6805	13.931
5	10.237	2.7046	5.8611	22.184
6	7.0057	1.8509	8.5645	32.416
8	3.9641	1.0473	15.136	57.289
10	2.4690	0.6523	24.301	91.981
12	1.6894	0.4463	35.516	134.43

Ordering Information

Part No.	Code	Description
P525-1	198 801 494	Metalex Flow sensor with tungsten carbide pin; ½ in. to 1 in. socket-weld tee fittings
P525-2	198 801 495	Metalex Flow sensor with tungsten carbide pin; 1¼ in. to 12 in. weld-on mini-tap fittings
P525-1S	159 000 963	Metalex Flow sensor with stainless steel pin; ½ in. to 1 in. socket-weld tee fittings
P525-2S	159 000 964	Metalex Flow sensor with stainless steel pin; 1¼ in. to 12 in. weld-on mini-tap fittings

Accessories and Replacement Parts

P52509	198 801 501	Rotor kit: rotors, 316 stainless steel pin, carbon fiber reinforced PTFE bearings, SS retainers
P52509-2	159 000 480	Rotor kit: rotors, tungsten carbide pin, carbon fiber reinforced PTFE bearings, SS retainers
P52504-1	198 801 500	Rotor Pin, Stainless steel (1.4401) (optional)
P52504-2	198 820 023	Rotor Pin, Tungsten Carbide (standard)
P52618	159 000 493	Gasket
P52503	198 820 013	Bearing, carbon fiber reinforced PTFE
P52527	159 000 481	Retainers, Stainless steel
P52628	159 000 504	Fitting cap kit (cap and gasket)
P51589	159 000 476	Conduit adapter kit
5523-3222	159 000 393	Cable (per foot) 2 cond. with shield, 22 AWG



Georg Fischer Signet LLC, 3401 Aero Jet Avenue, El Monte, CA 91731-2882 U.S.A. • Tel. (626) 571-2770 • Fax (626) 573-2057
For Worldwide Sales and Service, visit our website: www.gfsignet.com • Or call (in the U.S.): (800) 854-4090
For the most up-to-date information, please refer to our website at www.gfsignet.com